

bivaq

ES 2023

tarifa de precios
price list



| | |
|---------------------|----|
| garda | 04 |
| teja | 09 |
| illa | 14 |
| vint | 17 |
| sit | 23 |
| nak | 32 |
| nak65 | 36 |
| mood XL | 40 |
| nude | 43 |
| club | 45 |
| sirkel | 50 |
| dats | 56 |
| deco cushion | 60 |
| roll fabrics | 62 |
| paintings / fabrics | 64 |
| table tops | 65 |

Colección producida con tubo redondo de aluminio extruido y acabado con pintura poliéster. El tejido sling que da base a los almohadones confiere al sofá una sentada blanda y muy confortable. Sofas y sillones disponibles sin brazos, brazos de aluminio pintado o madera de iroko.

Tejido acrílico: 100% acrílico teñido en masa, resistente a los rayos UVA (clasif. 7/8), tratamiento antimanchas y repelente al agua. Lavable a 30° C. Secado al aire libre. **Tejido vinytex:** tejido sintético recubierto de poliéster. Resistente a los rayos UVA (clasif. 7/8). Lavable con jabón neutro diluido en una gran cantidad de agua.

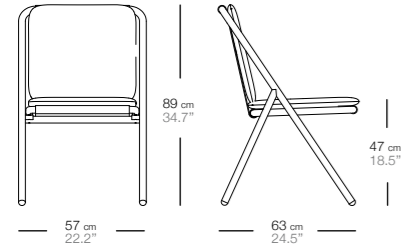

| garda silla sin brazos garda chair no armrest | código code | m ³ m ³ | kg kg | € |
|---|----------------|----------------------------------|----------|-----|
| sin brazo, color pintura / tejido sling no armrest, painting colour / sling fabric | 25119--/-- | 0,28 | 5,322 | 605 |
| funda impermeable waterproof cover | 251690025 | | | 235 |

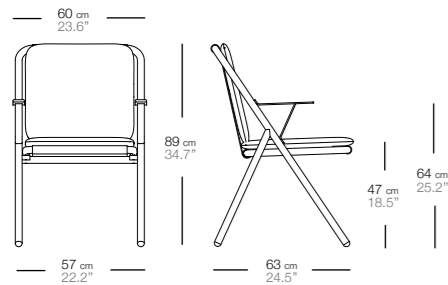

| garda sillón con brazos garda armchair | código code | m ³ m ³ | kg kg | € |
|---|----------------|----------------------------------|----------|-----|
| brazo aluminio, color pintura / tejido sling aluminum armrest, painting color / sling fabric | 25107--/-- | 0,28 | 5,72 | 770 |
| brazo madera, color pintura / tejido sling wood armrest, painting colour / sling fabric | 25108--/-- | 0,28 | 6,02 | 940 |
| funda impermeable waterproof cover | 251690025 | | | 235 |

Collection produced with round extruded aluminum tube and finished with powder coated polyester. The sling fabric that supports the cushions gives the sofa a soft and very comfortable seating. Sofas and armchairs are available without armrests, armrests in painted aluminum or iroko wood.

Acrylic fabric: 100% solution-dyed acrylic, UV-resistant (class 7/8), stain and water repellent treatment. Washable at 30°C. Air-drying. **Vinytex fabric:** synthetic fabric coated with polyester. Resistant to UVA rays (class 7/8). Washable with neutral soap diluted in a large amount of water.

| almohadón (asiento, respaldo) cushion (seat, back) | código code | € | Total chasis + alm as. + resp. € Total frame + seat cush. + back cush. € |
|---|----------------|-----|---|
| tejido A A fabric | 2510400-- | 335 | 940 |
| tejido B B fabric | 2510400-- | 340 | 945 |
| tejido C C fabric | 2510400-- | 385 | 990 |
| tejido D D fabric | 2510400-- | 420 | 1.025 |
| tejido cliente 137 cm.: COM fabric 54": | 251040099 | 335 | 940 |

Largo 112 cm.
Length 44"

| almohadón (asiento, respaldo) cushion (seat, back) | código code | € | Total chasis brazo alum. + as. + resp. € Total frame alu. armrest + seat cush. + back cush. € | Total chasis brazo madera + as. + resp. € Total frame wood armrest + seat cush. + back cush. € |
|---|----------------|-----|---|--|
| tejido A A fabric | 2510400-- | 335 | 1.105 | 1.275 |
| tejido B B fabric | 2510400-- | 340 | 1.110 | 1.280 |
| tejido C C fabric | 2510400-- | 385 | 1.155 | 1.325 |
| tejido D D fabric | 2510400-- | 420 | 1.190 | 1.360 |
| tejido cliente 137 cm.: COM fabric 54": | 251040099 | 335 | 1.105 | 1.275 |

Largo 112 cm.
Length 44"

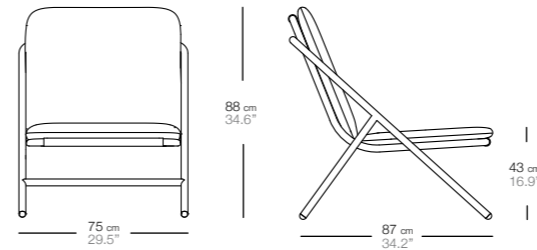

| garda sofá lounge sin brazo garda sofa lounge no armrest | código code | m ³ m ³ | kg kg | € |
|---|----------------|----------------------------------|----------|-------|
| sin brazo, color pintura / tejido sling no armrest, painting colour / sling fabric | 25209--/-- | 0,77 | 11 | 1.075 |
| funda impermeable waterproof cover | 251690025 | | | 310 |

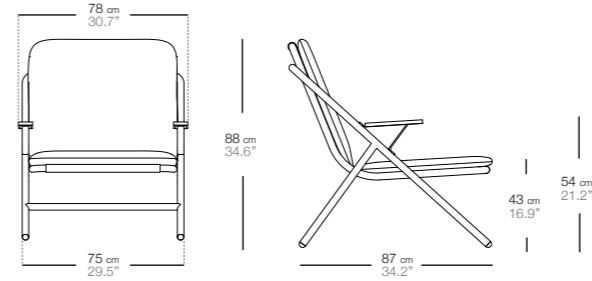

| garda sofá lounge con brazo garda sofa lounge with armrest | código code | m ³ m ³ | kg kg | € |
|--|----------------|----------------------------------|----------|-------|
| brazo aluminio, color pintura / tejido sling aluminum armrest, painting colour / sling fabric | 25207--/-- | 0,77 | 12 | 1.240 |
| brazo madera, color pintura / tejido sling wood armrest, painting colour / sling fabric | 25208--/-- | 0,77 | 12 | 1.415 |
| funda impermeable waterproof cover | 251690025 | | | 310 |

| almohadón (asiento, respaldo) cushion (seat, back) | código code | € | Total chasis + alm as. + resp. € Total frame + seat cush. + back cush. € |
|---|----------------|-----|---|
| tejido A A fabric | 2520400-- | 505 | 1.580 |
| tejido B B fabric | 2520400-- | 515 | 1.590 |
| tejido C C fabric | 2520400-- | 590 | 1.665 |
| tejido D D fabric | 2520400-- | 645 | 1.720 |
| tejido cliente 137 cm.: COM fabric 54": | 252040099 | 505 | 1.580 |

Largo 159 cm.
Length 62,6"

| almohadón (asiento, respaldo) cushion (seat, back) | código code | € | Total chasis brazo alum. + as. + resp. € Total frame alu. armrest + seat cush. + back cush. € | Total chasis brazo madera + as. + resp. € Total frame wood armrest + seat cush. + back cush. € |
|---|----------------|-----|---|--|
| tejido A A fabric | 2520400-- | 505 | 1.745 | 1.920 |
| tejido B B fabric | 2520400-- | 515 | 1.755 | 1.930 |
| tejido C C fabric | 2520400-- | 590 | 1.830 | 2.005 |
| tejido D D fabric | 2520400-- | 645 | 1.885 | 2.060 |
| tejido cliente 137 cm.: COM fabric 54": | 252040099 | 505 | 1.745 | 1.920 |

Largo 159 cm.
Length 62,6"

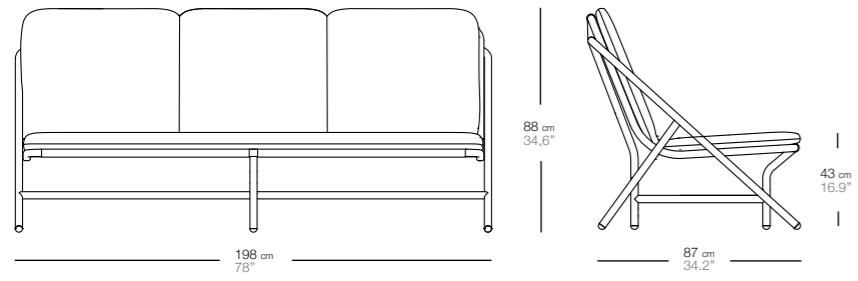

| garda asiento 3 plazas sin brazos garda 3 seater no armrest | código code | m ³ m ³ | kg kg | € € | + | almohadón (asiento, respaldo) cushion (seat, back) | código code | € € | Total chasis + alm as. + resp. € Total frame + seat cush. + back cush. € |
|---|-------------|-------------------------------|-------|-------|---|--|-------------|-------|--|
| sin brazo, color pintura / tejido sling no armrest, painting colour / sling fabric | 25229--/-- | 1,81 | 29 | 3.270 | + | tejido A A fabric | 2522000-- | 1.305 | 4575 |
| funda impermeable waterproof cover | 252290025 | | | 455 | | tejido B B fabric | 2522000-- | 1.335 | 4605 |
| | | | | | | tejido C C fabric | 2522000-- | 1.535 | 4805 |
| | | | | | | tejido D D fabric | 2522000-- | 1.695 | 4965 |
| | | | | | | tejido cliente 450 cm.: COM fabric 177,2": | 252200099 | 1.305 | 4575 |
| | | | | | | Largo 50 cm. Length 19,69" | | | |

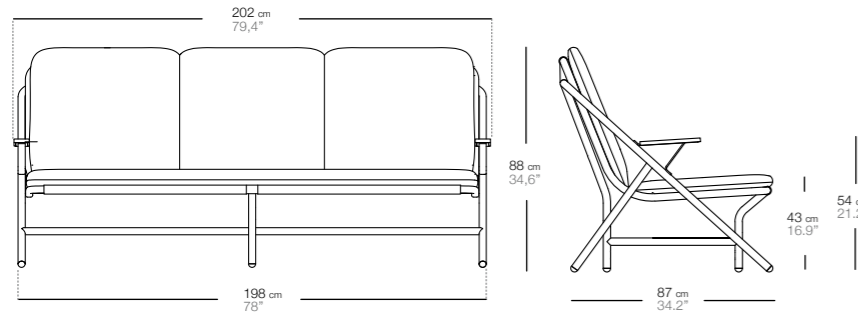

| garda asiento 3 plazas con brazos garda 3 seater with armrest | código code | m ³ m ³ | kg kg | € € | + | almohadón (1 asiento, 3 respaldos) cushion (1 seat, 3 backs) | código code | € € | Total chasis brazo alum. + as. + resp. € Total frame alu. armrest + seat cush. + back cush. € | Total chasis brazo madera + as. + resp. € Total frame wood armrest + seat cush. + back cush. € |
|--|-------------|-------------------------------|-------|-------|---|--|-------------|-------|---|--|
| brazo aluminio, color pintura / tejido sling aluminum armrest, painting colour / sling fabric | 25227--/-- | 1,81 | 29 | 3.435 | + | tejido A A fabric | 2522000-- | 1.305 | 4.740 | 4.910 |
| brazo madera, color pintura / tejido sling wood armrest, painting colour / sling fabric | 25228--/-- | 1,81 | 29 | 3.605 | | tejido B B fabric | 2522000-- | 1.335 | 4.770 | 4.940 |
| funda impermeable waterproof cover | 252290025 | | | 455 | | tejido C C fabric | 2522000-- | 1.535 | 4.970 | 5.140 |
| | | | | | | tejido D D fabric | 2522000-- | 1.695 | 5.130 | 5.300 |
| | | | | | | tejido cliente 137 cm.: COM fabric 54": | 252200099 | 1.305 | 4.740 | 4.910 |
| | | | | | | Largo 450 cm. Length 177,2" | | | | |

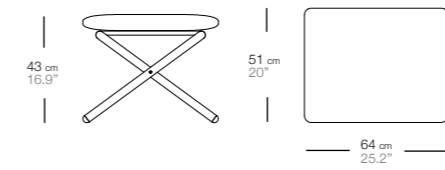

| garda reposapies garda footstool | código code | m ³ m ³ | kg kg | € € | | almohadón asiento seat cushion | código code | € € | Total chasis + alm as. + resp. € Total frame + seat cush. + back cush. € |
|---------------------------------------|-------------|-------------------------------|-------|-----|---|--|-------------|-----|--|
| color pintura painting colour | 2523710-- | 0,36 | 6 | 575 | | tejido A A fabric | 2523400-- | 265 | 840 |
| funda impermeable waterproof cover | 252390025 | | | 155 | + | tejido B B fabric | 2523400-- | 270 | 845 |
| | | | | | | tejido C C fabric | 2523400-- | 310 | 885 |
| | | | | | | tejido D D fabric | 2523400-- | 345 | 920 |
| | | | | | | tejido cliente 137 cm.: COM fabric 54": | 241050099 | 265 | 840 |
| | | | | | | Largo 68 cm. Length 26,5" | | | |

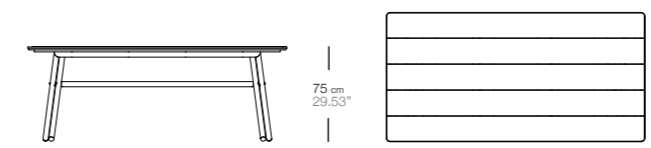

| garda mesa garda table | 240x100x75 w.94.5" d.39.4" h29.53" | código code | m ³ m ³ | kg kg | € € | 200x100x75 w.78.8" d.39.4" h29.53" | código code | m ³ m ³ | kg kg | € € |
|--|---------------------------------------|-------------|-------------------------------|-------|-------|---------------------------------------|-------------|-------------------------------|-------|-------|
| color pintura / sobre compacto blanco painting colour / white compact top | 25730--/50 | 25730--/50 | 0,5 | 65 | 2.975 | 25630--/50 | 25630--/50 | 0,41 | 55 | 2.975 |
| color pintura / lamas aluminio pintado painting colour / painted aluminum slats | 25730--/-- | 25730--/-- | 0,5 | 55 | 3.450 | 25630--/-- | 25630--/-- | 0,41 | 46 | 3.035 |
| color pintura / lamas madera iroko painting colour / iroko wood slats | 25730--/70 | 25730--/70 | 0,5 | 44 | 4.975 | 25630--/70 | 25630--/70 | 0,41 | 36 | 4.475 |
| color pintura / sobre dekton painting colour / dekton top | 25730--/-- | 25730--/-- | 0,5 | 98 | 3.650 | 25630--/-- | 25630--/-- | 0,41 | 83 | 3.340 |
| funda impermeable waterproof cover | 257390025 | 257390025 | | | 390 | 256390025 | 256390025 | | | 330 |

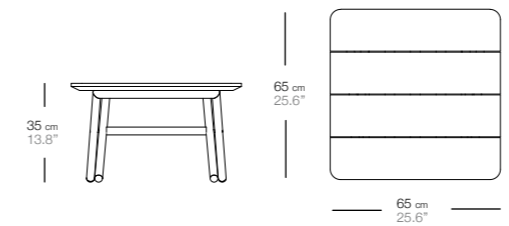

| garda mesa baja 65x65x35 garda low table 65x65x35 | código code | m ³ m ³ | kg kg | € € |
|--|-------------|-------------------------------|-------|-------|
| color pintura / sobre compacto blanco painting colour / white compact top | 25600--/50 | 0,36 | 11 | 775 |
| color pintura / lamas aluminio pintado painting colour / painted aluminum slats | 25600--/-- | 0,36 | 13 | 895 |
| color pintura / lamas madera iroko painting colour / iroko wood slats | 25600--/70 | 0,36 | 11 | 1.450 |
| color pintura / sobre dekton painting colour / dekton top | 25600--/-- | 0,36 | 17 | 1.185 |
| funda impermeable waterproof cover | 256096825 | | | 135 |

*CÓDIGOS COLORES PINTURA, TEJIDOS y SOBRES MESA. Ver páginas 64-65.
*PAINTING COLORS CODES, FABRICS and TABLE TOPS. See pages 64-65.

Colección compuesta por sillón comedor, sillón bajo, sofá 1 plaza, 2 p., 3 p., taburete bar y mesas bajas.

Estructura fabricada en aluminio extruido y acabada con pintura en polvo poliéster. Las bases de los sofás están disponibles en aluminio pintado o madera de iroko obtenida seleccionando los mejores troncos de plantaciones controladas y sostenibles.

Cada uno de los productos se trenza a mano, de forma totalmente artesanal utilizando cuerda marina compuesta de hilo poliéster y cordón interior de nylon, para asegurar la mayor duración y resistente a la intemperie.

This family includes dining armchair, low armchair, sofa 1 seater, 2 s., 3 s., bar stool and low tables.

Frame made of extruded aluminium and finished with polyester powder coating. Sofa's bases are available in painted aluminium or iroko wood obtained by selecting the best trees from controlled and sustainable plantations.

Each of the products is hand-woven, in a completely handmade way using marine rope composed of polyester thread and nylon inner cord, to ensure the longest duration and weather resistance.

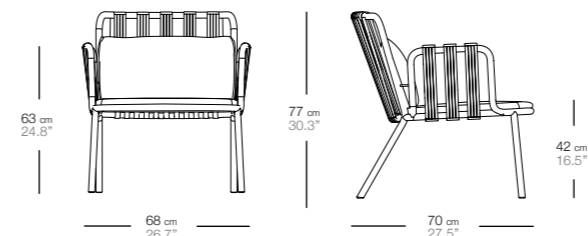
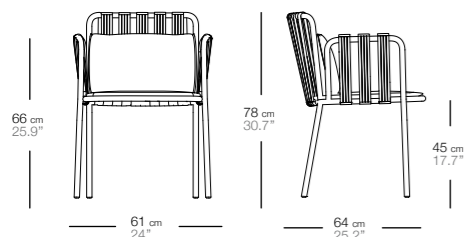

| teja sillón teja armchair | código code | m ³ m ³ | kg kg | € | | teja almohadón asiento teja seat cushion | código code | € | Total chasis + alm as. € Total frame + seat cush. € | teja sillón bajo teja low armchair | código code | m ³ m ³ | kg kg | € | | teja almohadón asiento teja seat cushion | código code | € | Total chasis + alm as. € Total frame + seat cush. € |
|--|----------------|----------------------------------|----------|-----|---|--|----------------|-----|---|--|----------------|----------------------------------|----------|-----|---|--|----------------|-----|---|
| color pintura / cuerda painting colour / rope | 24100--/-- | 0,45 | 8 | 570 | + | | | | | color pintura / cuerda painting colour / rope | 24160--/-- | 0,45 | 9 | 695 | + | | | | |
| funda impermeable waterproof cover | 241090025 | | | 235 | | tejido A A fabric | 2410500-- | 140 | 710 | funda impermeable waterproof cover | 241690025 | | | 285 | | tejido A A fabric | 2416500-- | 170 | 865 |
| | | | | | | tejido B B fabric | 2410500-- | 145 | 715 | | | | | | | tejido B B fabric | 2416500-- | 180 | 875 |
| | | | | | | tejido C C fabric | 2410500-- | 165 | 735 | | | | | | | tejido C C fabric | 2416500-- | 210 | 905 |
| | | | | | | tejido D D fabric | 2410500-- | 190 | 760 | | | | | | | tejido D D fabric | 2416500-- | 240 | 935 |
| | | | | | | tejido cliente 137 cm.: COM fabric 54": | 241050099 | 140 | 710 | | | | | | | tejido cliente 137 cm.: COM fabric 54": | 241650099 | 170 | 865 |
| | | | | | | Largo 50 cm. Length 19,69" | | | | | | | | | | Largo 57 cm. Length 22,44" | | | |
| | | | | | | teja almohadón respaldo teja back cushion | código code | € | Total chasis + alm as. + resp. € Total frame + seat cush. + back cush. € | | | | | | | teja almohadón respaldo teja back cushion | código code | € | Total chasis + alm as. + resp. € Total frame + seat cush. + back cush. € |
| | | | | | | tejido A A fabric | 2410400-- | 130 | 840 | | | | | | | tejido A A fabric | 2416400-- | 140 | 1.005 |
| | | | | | | tejido B B fabric | 2410400-- | 135 | 850 | | | | | | | tejido B B fabric | 2416400-- | 150 | 1.025 |
| | | | | | | tejido C C fabric | 2410400-- | 145 | 880 | | | | | | | tejido C C fabric | 2416400-- | 175 | 1.080 |
| | | | | | | tejido D D fabric | 2410400-- | 155 | 915 | | | | | | | tejido D D fabric | 2416400-- | 195 | 1.130 |
| | | | | | | tejido cliente 137 cm.: COM fabric 54": | 241040099 | 130 | 840 | | | | | | | tejido cliente 137 cm.: COM fabric 54": | 241640099 | 140 | 1.005 |
| | | | | | | Largo 30 cm. Length 11,81" | | | | | | | | | | | | | |

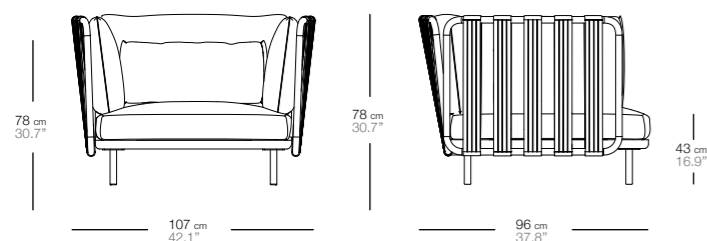

| teja sofá 1 plaza teja lounge sofa | código code | m ³ m ³ | kg kg | € | almohadón (asiento, respaldo) seater back cushion (seat, back) | código code | € | Total chasis + alm as. + resp. € Total frame + seat cush. + back cush. € |
|--|----------------|----------------------------------|----------|-------|---|----------------|-------|---|
| color pintura / cuerda painting colour / rope | 24203--/-- | 0,92 | 30 | 1.960 | tejido A A fabric | 2420000-- | 875 | 2.835 |
| funda impermeable waterproof cover | 242090025 | | | 310 | tejido B B fabric | 2420000-- | 895 | 2.855 |
| | | | | | tejido C C fabric | 2420000-- | 1.000 | 2.960 |
| | | | | | tejido D D fabric | 2420000-- | 1.085 | 3.045 |
| | | | | | tejido cliente 137 cm.: COM fabric 54": | 242000099 | 875 | 2.835 |
| | | | | | Largo 325 cm. Length 127,95" | | | |

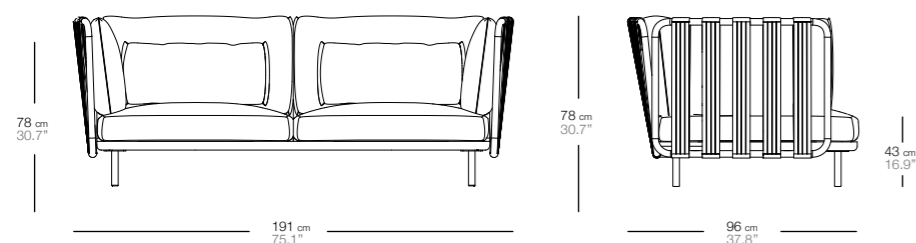

| teja sofá 2 plazas teja 2 seater sofa | código code | m ³ m ³ | kg kg | € | almohadón sofá 2 plazas (asiento, respaldo) 2 seat, 2 back cushion (seat, back) | código code | € | Total chasis + alm as. + resp. € Total frame + seat cush. + back cush. € |
|--|----------------|----------------------------------|----------|-------|---|----------------|-------|---|
| color pintura / cuerda painting colour / rope | 24213--/-- | 1,62 | 43 | 2.585 | tejido A A fabric | 2421000-- | 1.750 | 4.335 |
| funda impermeable waterproof cover | 242190025 | | | 380 | tejido B B fabric | 2421000-- | 1.790 | 4.375 |
| | | | | | tejido C C fabric | 2421000-- | 2.000 | 4.585 |
| | | | | | tejido D D fabric | 2421000-- | 2.170 | 4.755 |
| | | | | | tejido cliente 137 cm.: COM fabric 54": | 242100099 | 1.750 | 4.335 |
| | | | | | Largo 650 cm. Length 255,90" | | | |

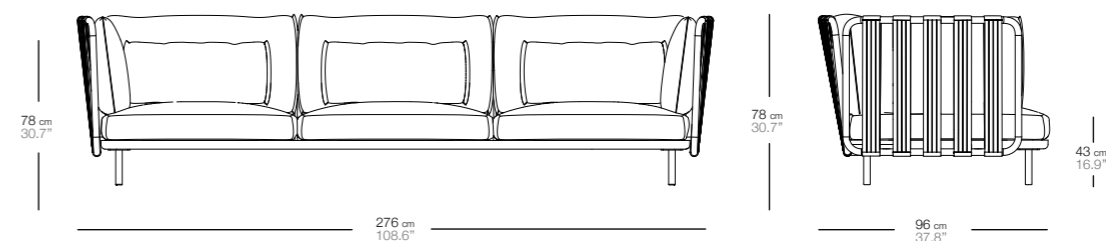

| teja sofá 3 plazas teja 3 seater sofa | código code | m ³ m ³ | kg kg | € | almohadón sofá 3 plazas (asiento, respaldo) 3 seat, 3 back cushion (seat, back) | código code | € | Total chasis + alm as. + resp. € Total frame + seat cush. + back cush. € |
|--|----------------|----------------------------------|----------|-------|---|----------------|-------|---|
| color pintura / cuerda painting colour / rope | 24223--/-- | 2,33 | 60 | 3.415 | tejido A A fabric | 2422000-- | 2.625 | 6.040 |
| funda impermeable waterproof cover | 242290025 | | | 455 | tejido B B fabric | 2422000-- | 2.685 | 6.100 |
| | | | | | tejido C C fabric | 2422000-- | 3.000 | 6.415 |
| | | | | | tejido D D fabric | 2422000-- | 3.255 | 6.670 |
| | | | | | tejido cliente 137 cm.: COM fabric 54": | 242200099 | 2.625 | 6.040 |
| | | | | | Largo 975 cm. Length 383,85" | | | |

| teja 1 cojín lateral teja side cushion | código code | € |
|--|----------------|-----|
| tejido A A fabric | 2420600-- | 185 |
| tejido B B fabric | 2420600-- | 190 |
| tejido C C fabric | 2420600-- | 210 |
| tejido D D fabric | 2420600-- | 230 |
| tejido cliente 137 cm.: COM fabric 54": | 242060099 | 185 |
| Largo 47 cm. Length 18,50" | | |

| teja 1 cojín decoración teja deco cushion 1 unit | 40x40 15,7"x15,7" | 60x30 23,6"x11,8" | 60x60 23,6"x23,6" | | | |
|---|----------------------|-------------------------------|----------------------|-------------------------------|-----------|-----|
| código code | € | código code | € | código code | € | |
| tejido A A fabric | 2484000-- | 110 | 2483000-- | 135 | 2488000-- | 165 |
| tejido B B fabric | 2484000-- | 120 | 2483000-- | 140 | 2488000-- | 175 |
| tejido C C fabric | 2484000-- | 140 | 2483000-- | 155 | 2488000-- | 200 |
| tejido D D fabric | 2484000-- | 160 | 2483000-- | 180 | 2488000-- | 225 |
| tejido cliente 137 cm.: COM fabric 54": | 248400099 | 110 | 248300099 | 135 | 248800099 | 165 |
| Largo 55 cm. Length 21,65" | | Largo 75 cm. Length 29,53" | | Largo 76 cm. Length 29,92" | | |

*CÓDIGOS COLORES PINTURA, TEJIDOS y SOBRES MESA. Ver páginas 64-65.
*PAINTING COLORS CODES, FABRICS and TABLE TOPS. See pages 64-65.

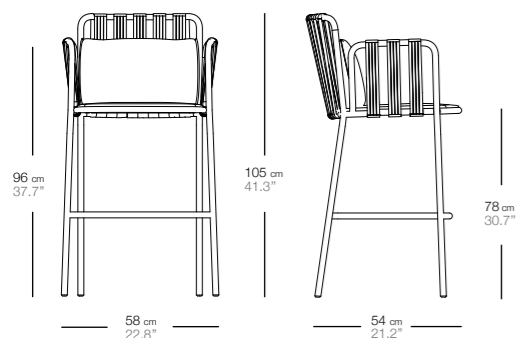

| teja taburete de bar teja barstool | código code | m ³ m ³ | kg kg | € |
|--|----------------|----------------------------------|----------|-----|
| color pintura / cuerda painting colour / rope | 24140--/-- | 0,41 | 8 | 555 |
| funda impermeable waterproof cover | 241490025 | | | 170 |

| teja almohadón asiento teja seat cushion | código code | € | Total chasis + alm as. € Total frame + seat cush. € |
|---|----------------|---|--|
|---|----------------|---|--|

| | | | |
|--|-----------|-----|-----|
| tejido A A fabric | 2410500-- | 140 | 695 |
| tejido B B fabric | 2410500-- | 145 | 700 |
| tejido C C fabric | 2410500-- | 165 | 720 |
| tejido D D fabric | 2410500-- | 190 | 745 |
| tejido cliente 137 cm.: COM fabric 54": | 241050099 | 140 | 695 |

Largo 50 cm.
Length 19,69"

| teja almohadón respaldo teja back cushion | código code | € | Total chasis + alm as. + resp. € Total frame + seat cush. + back cush. € |
|--|----------------|---|---|
|--|----------------|---|---|

| | | | |
|--|-----------|-----|-----|
| tejido A A fabric | 2410400-- | 130 | 825 |
| tejido B B fabric | 2410400-- | 135 | 835 |
| tejido C C fabric | 2410400-- | 145 | 865 |
| tejido D D fabric | 2410400-- | 155 | 900 |
| tejido cliente 137 cm.: COM fabric 54": | 241040099 | 130 | 825 |

Largo 30 cm.
Length 11,81"

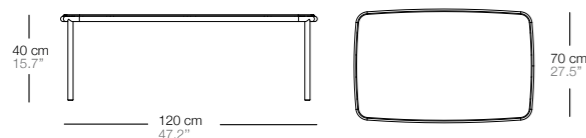

| teja mesa baja 120x70x40 teja low table 120x70x40 | código code | m ³ m ³ | kg kg | € |
|---|----------------|----------------------------------|----------|-------|
| color pintura / sobre compact blanco painting colour / white compact top | 24620--50 | 0,4 | 18 | 1.045 |
| color pintura / sobre aluminio painting colour / aluminum top | 24620--/-- | 0,4 | 21 | 1.285 |
| color pintura / lamas madera iroko painting colour / iroko wood slats | 24620--70 | 0,4 | 18 | 1.960 |
| color pintura / sobre dektion® painting colour / dektion® top | 24620--/-- | 0,4 | 28 | 1.980 |
| funda impermeable waterproof cover | 246290025 | | | 255 |

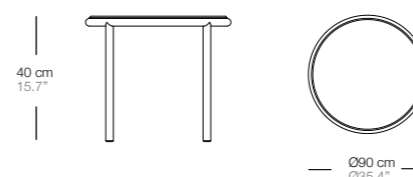

| teja mesa baja Ø90x40 teja low table Ø90x40 | código code | m ³ m ³ | kg kg | € |
|---|----------------|----------------------------------|----------|-------|
| color pintura / sobre compact blanco painting colour / white compact top | 24610--50 | 0,39 | 17 | 990 |
| color pintura / sobre aluminio painting colour / aluminum top | 24610--/-- | 0,39 | 22 | 1.195 |
| color pintura / lamas madera iroko painting colour / iroko wood slats | 24610--70 | 0,39 | 18 | 1.830 |
| color pintura / sobre dektion® painting colour / dektion® top | 24610--/-- | 0,39 | 29 | 1.615 |
| funda impermeable waterproof cover | 246190025 | | | 230 |

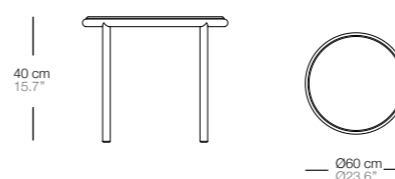

| teja mesa baja Ø60x40 teja low table Ø60x40 | código code | m ³ m ³ | kg kg | € |
|---|----------------|----------------------------------|----------|-------|
| color pintura / sobre compact blanco painting colour / white compact top | 24740--50 | 0,18 | 8 | 630 |
| color pintura / sobre aluminio painting colour / aluminum top | 24740--/-- | 0,18 | 9 | 630 |
| color pintura / lamas madera iroko painting colour / iroko wood slats | 24740--70 | 0,18 | 8 | 1.120 |
| color pintura / sobre dektion® painting colour / dektion® top | 24740--/-- | 0,18 | 12 | 965 |
| funda impermeable waterproof cover | 247490025 | | | 140 |

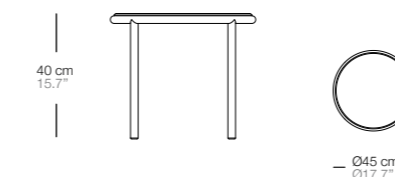

| teja mesa baja Ø45x40 teja low table Ø45x40 | código code | m ³ m ³ | kg kg | € |
|---|----------------|----------------------------------|----------|-----|
| color pintura / sobre compact blanco painting colour / white compact top | 24730--50 | 0,18 | 5 | 565 |
| color pintura / sobre aluminio painting colour / aluminum top | 24730--/-- | 0,18 | 6 | 565 |
| color pintura / lamas madera iroko painting colour / iroko wood slats | 24730--70 | 0,18 | 5 | 875 |
| color pintura / sobre dektion® painting colour / dektion® top | 24730--/-- | 0,18 | 7 | 770 |
| funda impermeable waterproof cover | 247390025 | | | 120 |

Colección de sillones, sillas, mesas comedor y bajas fabricados con estructura de varilla y recubierto de pintura poliéster.

Tejido acrílico: 100% acrílico teñido en masa, resistente a los rayos UVA (clasif. 7/8), tratamiento antimanchas y repelente al agua. Lavabale a 30° C. Secado al aire libre.

Tejido vinytex: tejido sintético recubierto de poliéster. Resistente a los rayos UVA (clasif. 7/8). Lavable con jabón neutro diluido en una gran cantidad de agua.

Armchairs, chair, dining and low table collection, manufactured with an extruded aluminium structure, conifed legs and final finish made with polyester powder coating.

Acrylic fabric: 100% solution dyed acrylic, UV resistance (class. 7/8) with stain and water repellent finish. Washable at 30°C. Open air drying.

Vinytex fabric: synthetic fabric made of plastic coated polyester. UV resistance (class. 7/8). It is recommended to clean it with neutral soap diluted in large quantity of water.

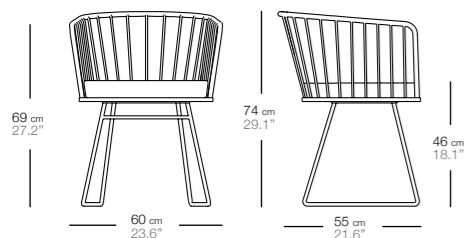

| illa sillón armchair | código code | m ³ m ³ | kg kg | € |
|---------------------------------------|----------------|----------------------------------|----------|-----|
| color pintura painting colour | 2010300-- | 0,33 | 9 | 580 |
| funda impermeable waterproof cover | 201090025 | | | 235 |

illa sillón, cojín asiento
armchair, seat cushion

| código code | € | Total chasis + alm as. € Total frame + seat cush. € |
|--|-----------|--|
| tejido A A fabric | 2010500-- | 125 705 |
| tejido B B fabric | 2010500-- | 130 710 |
| tejido C C fabric | 2010500-- | 155 735 |
| tejido D D fabric | 2010500-- | 175 755 |
| tejido cliente 137 cm.: COM fabric 54": | 201050099 | 125 705 |
| Largo 130 cm. Length 51,18" | | |

illa sillón, cojín respaldo
armchair, back cushion

| código code | € | Total chasis + alm as. + resp. € Total frame + seat cush. + back cush. € |
|--|-----------|---|
| tejido A A fabric | 2084400-- | 105 810 |
| tejido B B fabric | 2084400-- | 110 820 |
| tejido C C fabric | 2084400-- | 130 865 |
| tejido D D fabric | 2084400-- | 145 900 |
| tejido cliente 137 cm.: COM fabric 54": | 208440099 | 105 810 |
| Largo 95 cm. Length 0,37" | | |

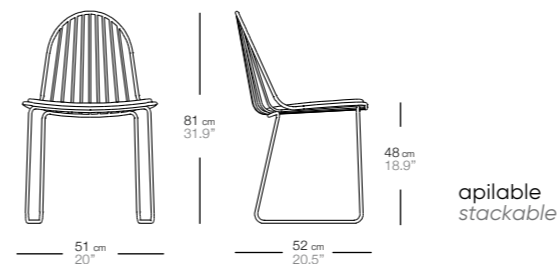

| illa silla chair | código code | m ³ m ³ | kg kg | € |
|---------------------------------------|----------------|----------------------------------|----------|-----|
| color pintura painting colour | 2011000-- | 0,33 | 10 | 510 |
| funda impermeable waterproof cover | 201190025 | | | 235 |

| illa silla, cojín asiento | código code | € | Total chasis + alm as. € Total frame + seat cush. € |
|--|----------------|-----|--|
| tejido A A fabric | 2011014-- | 100 | 610 |
| tejido B B fabric | 2011014-- | 105 | 615 |
| tejido C C fabric | 2011014-- | 115 | 625 |
| tejido D D fabric | 2011014-- | 125 | 635 |
| tejido cliente 137 cm.: COM fabric 54": | 201101499 | 100 | 610 |
| Largo 70 cm. Length 27,56" | | | |

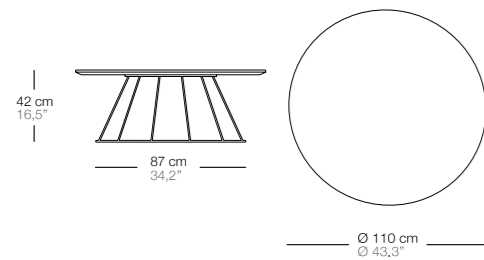

El sobre y las patas se sirven desmontadas (2 cajas)
excepto sobre Aluminio (1 caja)
Table top and legs are delivered unassembled (2 boxes)
except Aluminum table top (1 box)

illa mesa baja Ø110x40
low table Ø110x40

color pintura / sobre compact blanco
painting colour / white compact top

color pintura / sobre aluminio
painting colour / aluminum top

color pintura / sobre madera iroko
painting colour / iroko wood top

color pintura / sobre dektion
painting colour / dektion top

funda impermeable
waterproof cover

código
code

m³
m³

kg
kg

€

20610--50

0,6

23,6

1.075

20610--/--

0,6

28

1.285

20610--70

0,6

24

1.830

20610--/--

0,6

37

2.250

206199325

230

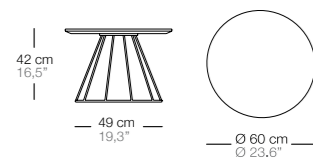

illa mesa baja Ø60x40
low table Ø60x40

color pintura / sobre compact blanco
painting colour / white compact top

color pintura / sobre aluminio
painting colour / aluminum top

color pintura / sobre madera iroko
painting colour / iroko wood top

color pintura / sobre dektion
painting colour / dektion top

funda impermeable
waterproof cover

código
code

m³
m³

kg
kg

€

20740--50

0,26

9

605

20740--/--

0,26

10,3

605

20740--70

0,26

9,2

1.165

20740--/--

0,26

13

945

207499325

140

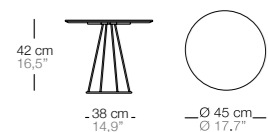

illa mesa baja Ø45x40
low table Ø45x40

color pintura / sobre compact blanco
painting colour / white compact top

color pintura / sobre aluminio
painting colour / aluminum top

color pintura / sobre madera iroko
painting colour / iroko wood top

color pintura / sobre dektion
painting colour / dektion top

funda impermeable
waterproof cover

código
code

m³
m³

kg
kg

€

20730--50

0,14

5,5

540

20730--/--

0,14

6,2

540

20730--70

0,14

5,5

875

20730--/--

0,14

8

895

207399325

120

Colección de sillones, butacas, sofás, mesas comedor y bajas fabricados con estructura de aluminio extruido, patas conificadas y recubierto de pintura poliéster.

Tejido acrílico: 100% acrílico teñido en masa, resistente a los rayos UVA (clasif. 7/8), tratamiento antimanchas y repelente al agua. Lavable a 30° C. Secado al aire libre.

Tejido vinytex: tejido sintético recubierto de poliéster. Resistente a los rayos UVA (clasif. 7/8). Lavable con jabón neutro diluido en una gran cantidad de agua.

Sofas, armchairs, dining and low table collection, manufactured with an extruded aluminium structure, conifed legs and final finish made with polyester powder coating.

Acrylic fabric: 100% solution dyed acrylic, UV resistance (class. 7/8) with stain and water repellent finish. Washable at 30°C. Open air drying.

Vinytex fabric: synthetic fabric made of plastic coated polyester. UV resistance (class. 7/8). It is recommended to clean it with neutral soap diluted in large quantity of water.

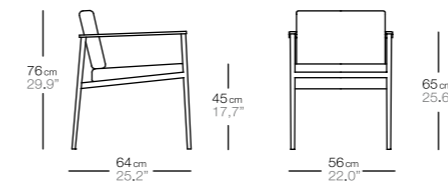

vint sillón
armchair

código
code

m³
m³

kg
kg

€

almohadón asiento, respaldo
1 seat, back cushion

código
code

€

Total chasis + alm as. + resp. €
Total frame + seat cush. + back cush. €

color pintura
painting colour

1410310--

0,43

6

495

+

funda impermeable
waterproof cover

141090025

235

tejido A
A fabric

1410400--

370

865

tejido B
B fabric

1410400--

385

880

tejido C
C fabric

1410400--

435

930

tejido D
D fabric

1410400--

495

990

tejido cliente 137 cm.:
COM fabric 54":

141040099

370

865

Largo 150 cm.
Length 59,06"

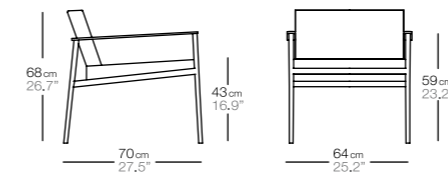

vint sillón bajo
low armchair

código
code

m³
m³

kg
kg

€

almohadón asiento, respaldo
1 seat, back cushion

código
code

€

Total chasis + alm as. + resp. €
Total frame + seat cush. + back cush. €

color pintura
painting colour

1420310--

0,52

7

530

+

funda impermeable
waterproof cover

142090025

280

tejido A
A fabric

1416400--

450

980

tejido B
B fabric

1416400--

465

995

tejido C
C fabric

1416400--

530

1060

tejido D
D fabric

1416400--

570

1100

tejido cliente 137 cm.:
COM fabric 54":

141640099

450

980

Largo 170 cm.
Length 66,93"

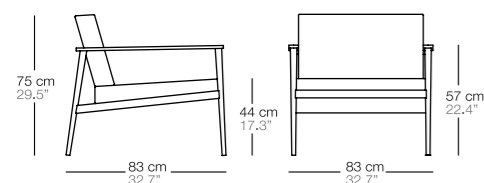

| vint sofá 1 plaza loungé sofa | código code | m ³ m ³ | kg kg | € | + | almohadón sofá 1 plaza (asiento, respaldo) loungé cushion (seat, back) | código code | € | Total chasis + alm. as. + resp. € Total frame + seat cush. + back cush. € |
|---------------------------------------|----------------|----------------------------------|----------|-----|---|---|----------------|-----|--|
| color pintura painting colour | 1420710-- | 0,56 | 19 | 960 | | | | | |
| funda impermeable waterproof cover | 141690025 | | | 310 | | | | | |
| | | | | | | tejido A A fabric | 1420400-- | 610 | 1.570 |
| | | | | | | tejido B B fabric | 1420400-- | 620 | 1.580 |
| | | | | | | tejido C C fabric | 1420400-- | 690 | 1.650 |
| | | | | | | tejido D D fabric | 1420400-- | 745 | 1.705 |
| | | | | | | tejido cliente 137 cm.: COM fabric 54": | 142040099 | 610 | 1.570 |
| | | | | | | Largo 230 cm. Length 90,55" | | | |

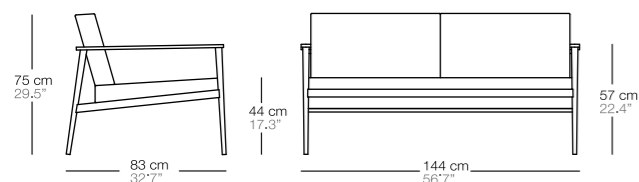

| vint sofá 2 plazas 2 seater sofa | código code | m ³ m ³ | kg kg | € | + | almohadón sofá 2 plazas (asiento, respaldo) 2 seater sofa cushion (seat, back) | código code | € | Total chasis + alm. as. + resp. € Total frame + seat cush. + back cush. € |
|---------------------------------------|----------------|----------------------------------|----------|-------|---|---|----------------|-------|--|
| color pintura painting colour | 1421710-- | 1,02 | 34 | 1.550 | | | | | |
| funda impermeable waterproof cover | 142190025 | | | 330 | | | | | |
| | | | | | | tejido A A fabric | 1421400-- | 1.045 | 2.595 |
| | | | | | | tejido B B fabric | 1421400-- | 1.095 | 2.645 |
| | | | | | | tejido C C fabric | 1421400-- | 1.200 | 2.750 |
| | | | | | | tejido D D fabric | 1421400-- | 1.300 | 2.850 |
| | | | | | | tejido cliente 137 cm.: COM fabric 54": | 142140099 | 1.045 | 2.595 |
| | | | | | | Largo 425 cm. Length 167,32" | | | |

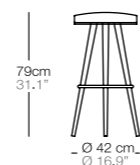

| vint taburete alto high barstool | código code | m ³ m ³ | kg kg | € | + | almohadón asiento seat cushion | código code | € | Total chasis + alm. as. € Total frame + seat cush. € |
|---------------------------------------|----------------|----------------------------------|----------|-----|---|--|----------------|-----|---|
| color pintura painting colour | 1414310-- | 0,84 | 14,5 | 615 | | | | | |
| funda impermeable waterproof cover | 141490025 | | | 170 | | | | | |
| | | | | | | tejido A A fabric | 1414500-- | 290 | 905 |
| | | | | | | tejido B B fabric | 1414500-- | 295 | 910 |
| | | | | | | tejido C C fabric | 1414500-- | 310 | 925 |
| | | | | | | tejido D D fabric | 1414500-- | 330 | 945 |
| | | | | | | tejido cliente 137 cm.: COM fabric 54": | 141450099 | 290 | 905 |
| | | | | | | Largo 0,4 cm. Length 0,16" | | | |

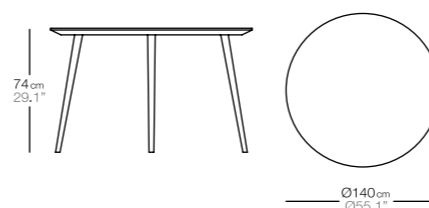

El sobre y las patas se sirven desmontadas
Table top and legs are delivered unassembled

| vint mesa Ø 140x74 table Ø 140x74 | código code | m ³ m ³ | kg kg | € |
|---|----------------|----------------------------------|----------|-------|
| color pintura / sobre compact blanco painting colour / white compact top | 14420--50 | 0,21 | 30 | 1.975 |
| color pintura / sobre madera iroko painting colour / iroko wood top | 14420--70 | 0,21 | 31 | 3.130 |
| color pintura / sobre dekon painting colour / dekon top | 14420--/-- | 0,21 | 52 | 3.400 |
| funda impermeable waterproof cover | 144099325 | | | 295 |

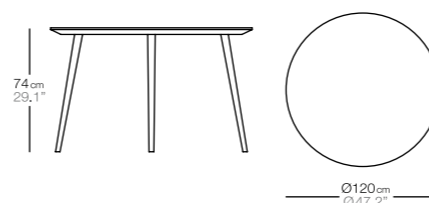

El sobre y las patas se sirven desmontadas
Table top and legs are delivered unassembled

| vint mesa Ø 120x74 table Ø 120x74 | código code | m ³ m ³ | kg kg | € |
|---|----------------|----------------------------------|----------|-------|
| color pintura / sobre compact blanco painting colour / white compact top | 14410--50 | 0,17 | 22 | 1.500 |
| color pintura / sobre madera iroko painting colour / iroko wood top | 14410--70 | 0,17 | 23 | 2.625 |
| color pintura / sobre dekon painting colour / dekon top | 14410--/-- | 0,17 | 38 | 2.985 |
| funda impermeable waterproof cover | 144099425 | | | 255 |

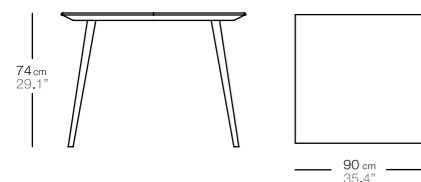

El sobre y las patas se sirven desmontadas
Table top and legs are delivered unassembled

vint mesa 90x90x74
table 90x90x74

código
code

m³
m³

kg
kg

€

color pintura / sobre compact blanco
painting colour / white compact top

14380--50

0,11

13

1.300

color pintura / sobre madera iroko
painting colour / iroko wood top

14380--70

0,11

14

2.260

color pintura / sobre dekton
painting colour / dekton top

14380--/--

0,11

20

1.850

funda impermeable
waterproof cover

144096870

230

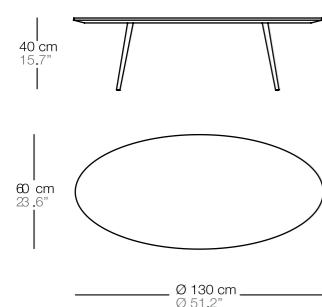

vint mesa baja oval 130x60x40
oval low table 130x60x40

código
code

m³
m³

kg
kg

€

color pintura / sobre compact blanco
painting colour / white compact top

14620--50

0,2

20

850

color pintura / sobre madera iroko
painting colour / iroko wood top

14620--70

0,2

21

1.810

funda impermeable
waterproof cover

146098825

255

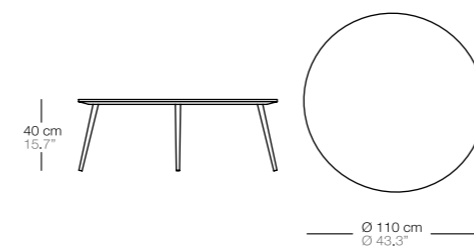

vint mesa baja Ø 110x40
low table Ø 110x40

código
code

m³
m³

kg
kg

€

color pintura / sobre compact blanco
painting colour / white compact top

14610--50

0,2

21

1.050

color pintura / sobre aluminio pintado
painting colour / painted aluminum top

14610--/--

0,2

23

1.250

color pintura / sobre madera iroko
painting colour / iroko wood top

14610--70

0,2

21

2.265

color pintura / sobre dekton
painting colour / dekton top

14610--/--

0,2

34

2.395

funda impermeable
waterproof cover

146095725

230

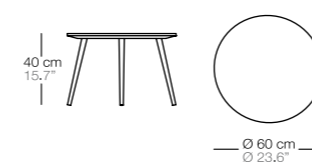

vint mesa baja Ø 60x40
low table Ø 60x40

código
code

m³
m³

kg
kg

€

color pintura / sobre compact blanco
painting colour / white compact top

14740--50

0,06

8

605

color pintura / sobre aluminio pintado
painting colour / painted aluminum top

14740--/--

0,06

9

540

color pintura / sobre madera iroko
painting colour / iroko wood top

14740--70

0,06

8

1.150

color pintura / sobre dekton
painting colour / dekton top

14740--/--

0,06

12

1.295

funda impermeable
waterproof cover

147098225

140



vint mesa baja Ø 45x40
low table Ø 45x40

código
code

m³
m³

kg
kg

€

color pintura / sobre compact blanco
painting colour / white compact top

14730--50

0,04

5

485

color pintura / sobre aluminio pintado
painting colour / painted aluminum top

14730--/--

0,04

6

455

color pintura / sobre madera iroko
painting colour / iroko wood top

14730--70

0,04

5

890

color pintura / sobre dekton
painting colour / dekton top

14730--/--

0,04

7,5

975

funda impermeable
waterproof cover

144098325

120

Sistema modular de sofás fabricados con estructura de aluminio extruido y recubierto de pintura poliéster.

Tejido acrílico: 100% acrílico teñido en masa, resistente a los rayos UVA (clasif. 7/8), tratamiento antimanchas y repelente al agua.

Lavable a 30° C. Secado al aire libre.

Tejido vinytex: tejido sintético recubierto de poliéster. Resistente a los rayos UVA (clasif. 7/8). Lavable con jabón neutro diluido en una gran cantidad de agua.

Modular system of sofas manufactured with an extruded aluminium structure and final finish made with polyester powder coating.

Acrylic fabric: 100% solution dyed acrylic, UV resistance (class. 7/8) with stain and water repellent finish. Washable at 30°C.

Open air drying. **Vinytex fabric:** synthetic fabric made of plastic coated polyester. UV resistance (class. 7/8). It is recommended to clean it with neutral soap diluted in large quantity of water.

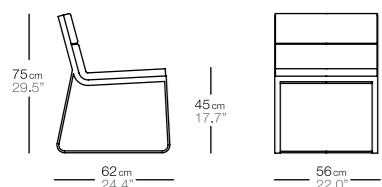

| sit silla chair | código code | m ³ m ³ | kg kg | € | | almohadón (asiento, respaldo) cushion (seat, back) | código code | € | Total chasis + alm as. + resp. € Total frame + seat cush. + back cush. € |
|---------------------------------------|----------------|----------------------------------|----------|-----|---|---|----------------|---|---|
| color pintura painting colour | 1211310-- | 0,43 | 8 | 495 | + | | | | |
| funda impermeable waterproof cover | 121190025 | | | 235 | | | | | |

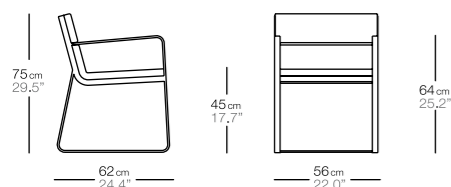

| sit sillón armchair | código code | m ³ m ³ | kg kg | € | | almohadón (asiento, respaldo) cushion (seat, back) | código code | € | Total chasis + alm as. + resp. € Total frame + seat cush. + back cush. € |
|---------------------------------------|----------------|----------------------------------|----------|-----|---|---|----------------|---|---|
| color pintura painting colour | 1210310-- | 0,43 | 10 | 545 | + | | | | |
| funda impermeable waterproof cover | 121090025 | | | 235 | | | | | |

| | | | |
|--|-----------|-----|-----|
| tejido A A fabric | 1210400-- | 290 | 785 |
| tejido B B fabric | 1210400-- | 300 | 795 |
| tejido C C fabric | 1210400-- | 360 | 855 |
| tejido D D fabric | 1210400-- | 410 | 905 |
| tejido cliente 137 cm.: COM fabric 54": | 121040099 | 290 | 785 |
| Largo 125 cm. Length 49,21" | | | |

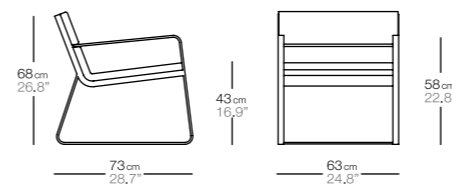

| sit sillón bajo low armchair | código code | m ³ m ³ | kg kg | € | | almohadón (asiento, respaldo) cushion (seat, back) | código code | € | Total chasis + alm as. + resp. € Total frame + seat cush. + back cush. € |
|--|----------------|----------------------------------|----------|-----|---|---|----------------|---|---|
| color pintura painting colour | 1220310-- | 0,51 | 13 | 630 | + | | | | |
| funda impermeable waterproof cover | 122090025 | | | 275 | | | | | |
| tejido A A fabric | 1216400-- | 405 | 1.035 | | | | | | |
| tejido B B fabric | 1216400-- | 420 | 1.050 | | | | | | |
| tejido C C fabric | 1216400-- | 485 | 1.115 | | | | | | |
| tejido D D fabric | 1216400-- | 535 | 1.165 | | | | | | |
| tejido cliente 137 cm.: COM fabric 54": | 121640099 | 405 | 1.035 | | | | | | |
| Largo 160 cm. Length 62,99" | | | | | | | | | |

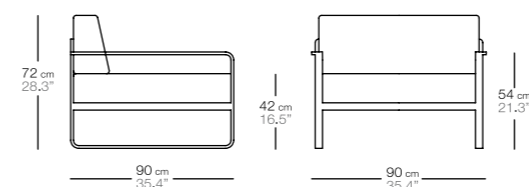

| sit sofá 1 plaza lounge sofa | código code | m ³ m ³ | kg kg | € | | almohadón sofá 1 plaza (asiento, respaldo) lounge cushion (seat, back) | código code | € | Total chasis + alm as. + resp. € Total frame + seat cush. + back cush. € |
|--|----------------|----------------------------------|----------|-------|---|---|----------------|---|---|
| color pintura painting colour | 1220710-- | 0,75 | 30 | 1.095 | + | | | | |
| funda impermeable waterproof cover | 121690025 | | | 310 | | | | | |
| tejido A A fabric | 1220400-- | 955 | 2.050 | | | | | | |
| tejido B B fabric | 1220400-- | 980 | 2.075 | | | | | | |
| tejido C C fabric | 1220400-- | 1.095 | 2.190 | | | | | | |
| tejido D D fabric | 1220400-- | 1.165 | 2.260 | | | | | | |
| tejido cliente 137 cm.: COM fabric 54": | 122040099 | 955 | 2.050 | | | | | | |
| Largo 370 cm. Length 145,67" | | | | | | | | | |

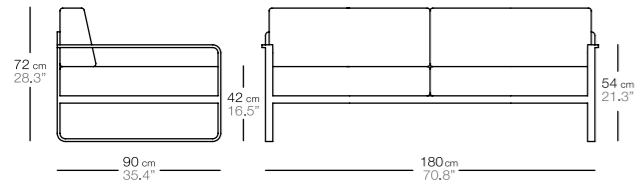

| sit sofá 2 plazas, brazos 2 seater sofa, armrests | código code | m ³ m ³ | kg kg | € |
|--|----------------|----------------------------------|----------|-------|
| color pintura painting colour | 1221710-- | 1,19 | 47 | 1.680 |
| funda impermeable waterproof cover | 122190025 | 1,19 | 47 | 330 |

| almohadón sofá 2 plazas (2 asientos, 2 respaldos) 2 seater sofa cushion (2 seats, 2 backs) | código code | € | Total chasis + alm as. + resp. € Total frame + seat cush. + back cush. € |
|---|----------------|-------|---|
| tejido A A fabric | 1221400-- | 1.910 | 3.590 |
| tejido B B fabric | 1221400-- | 1.960 | 3.640 |
| tejido C C fabric | 1221400-- | 2.190 | 3.870 |
| tejido D D fabric | 1221400-- | 2.330 | 4.010 |
| tejido cliente 137 cm.: COM fabric 54": Largo 515 cm. Length 202,76" | 122140099 | 1.910 | 3.590 |

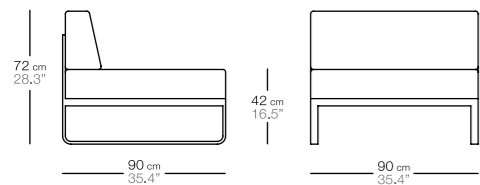

| sit central XL centre XL | código code | m ³ m ³ | kg kg | € |
|---------------------------------------|----------------|----------------------------------|----------|-----|
| color pintura painting colour | 1224710-- | 0,75 | 27 | 875 |
| funda impermeable waterproof cover | 122490025 | | | 310 |

| almohadón central XL (asiento, respaldo) XL centre cushion (seat, back) | código code | € | Total chasis + alm as. + resp. € Total frame + seat cush. + back cush. € |
|--|----------------|-------|---|
| tejido A A fabric | 1224400-- | 955 | 1.830 |
| tejido B B fabric | 1224400-- | 980 | 1.855 |
| tejido C C fabric | 1224400-- | 1.095 | 1.970 |
| tejido D D fabric | 1224400-- | 1.165 | 2.040 |
| tejido cliente 137 cm.: COM fabric 54": Largo 370 cm. Length 145,67" | 122440099 | 955 | 1.830 |

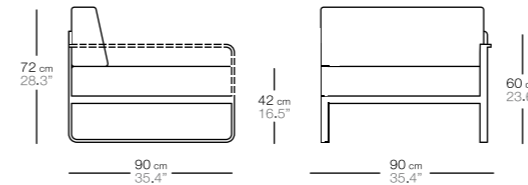

| sit lateral izquierdo left side | código code | m ³ m ³ | kg kg | € |
|---------------------------------------|----------------|----------------------------------|----------|-------|
| color pintura painting colour | 1226010-- | 0,75 | 30 | 1.015 |
| funda impermeable waterproof cover | 122690125 | | | 310 |

| almohadón mód. lateral (1 asiento, 1 respaldo largo) side module cushion (1 seat, 1 long back) | código code | € | Total chasis + alm as. + resp. € Total frame + seat cush. + back cush. € |
|---|----------------|-------|---|
| tejido A A fabric | 1225500-- | 955 | 1.970 |
| tejido B B fabric | 1225500-- | 980 | 1.995 |
| tejido C C fabric | 1225500-- | 1.095 | 2.110 |
| tejido D D fabric | 1225500-- | 1.165 | 2.180 |
| tejido cliente 137 cm.: COM fabric 54": Largo 370 cm. Length 145,67" | 122550099 | 955 | 1.970 |

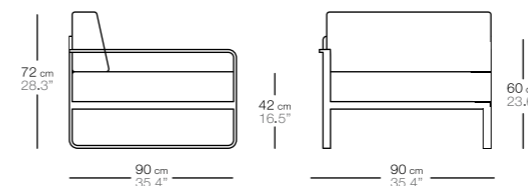

| sit lateral derecho right side | código code | m ³ m ³ | kg kg | € |
|---------------------------------------|----------------|----------------------------------|----------|-------|
| color pintura painting colour | 1225010-- | 0,75 | 30 | 1.015 |
| funda impermeable waterproof cover | 122590125 | | | 310 |

| almohadón mód. lateral (1 asiento, 1 respaldo largo) side module cushion (1 seat, 1 long back) | código code | € | Total chasis + alm as. + resp. € Total frame + seat cush. + back cush. € |
|---|----------------|-------|---|
| tejido A A fabric | 1225400-- | 955 | 1.970 |
| tejido B B fabric | 1225400-- | 980 | 1.995 |
| tejido C C fabric | 1225400-- | 1.095 | 2.110 |
| tejido D D fabric | 1225400-- | 1.165 | 2.180 |
| tejido cliente 137 cm.: COM fabric 54": Largo 370 cm. Length 145,67" | 122540099 | 955 | 1.970 |

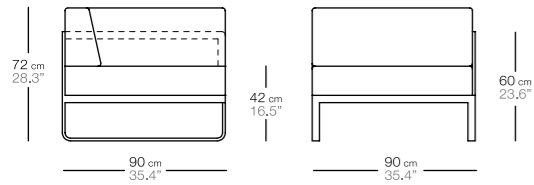

| | | | | | |
|--|------------------------------|--|------------------------|----------|----------|
| sit esquinero izquierdo <i>left corner</i> | código <i>code</i> | m³ <i>m³</i> | kg <i>kg</i> | € | + |
| color pintura <i>painting colour</i> | 1229010-- | 0,75 | 30 | 1.015 | |
| funda impermeable <i>waterproof cover</i> | 122990025 | | | 310 | |

| | | | |
|---|------------------------------|----------|---|
| almohadón esquinero izquierdo <i>left corner cushion</i> (1 asiento, 2 respaldos) (1 seat, 2 backs) | código <i>code</i> | € | Total chasis + alm as. + resp. € <i>Total frame + seat cush. + back cush. €</i> |
| tejido A <i>A fabric</i> | 1229400-- | 1.105 | 2.120 |
| tejido B <i>B fabric</i> | 1229400-- | 1.135 | 2.150 |
| tejido C <i>C fabric</i> | 1229400-- | 1.300 | 2.315 |
| tejido D <i>D fabric</i> | 1229400-- | 1.415 | 2.430 |
| tejido cliente 137 cm.: <i>COM fabric 54"</i> : Largo 470 cm. <i>Length 185,04"</i> | 122940099 | 1.105 | 2.120 |

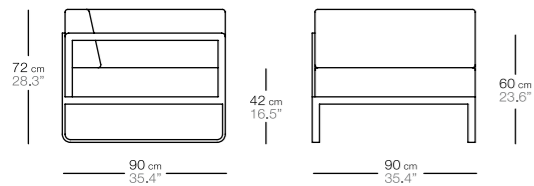

| | | | | | |
|---|------------------------------|--|------------------------|----------|----------|
| sit esquinero derecha <i>right corner</i> | código <i>code</i> | m³ <i>m³</i> | kg <i>kg</i> | € | + |
| color pintura <i>painting colour</i> | 1227010-- | 0,75 | 30 | 1.015 | |
| funda impermeable <i>waterproof cover</i> | 122790025 | | | 310 | |

| | | | |
|--|------------------------------|----------|---|
| almohadón esquinero derecho <i>right corner cushion</i> (1 asiento, 2 respaldos) (1 seat, 2 backs) | código <i>code</i> | € | Total chasis + alm as. + resp. € <i>Total frame + seat cush. + back cush. €</i> |
| tejido A <i>A fabric</i> | 1227400-- | 1.105 | 2.120 |
| tejido B <i>B fabric</i> | 1227400-- | 1.135 | 2.150 |
| tejido C <i>C fabric</i> | 1227400-- | 1.300 | 2.315 |
| tejido D <i>D fabric</i> | 1227400-- | 1.415 | 2.430 |
| tejido cliente 137 cm.: <i>COM fabric 54"</i> : Largo 470 cm. <i>Length 185,04"</i> | 122740099 | 1.105 | 2.120 |

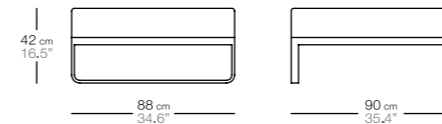

| | | | | | |
|--|------------------------------|--|------------------------|----------|----------|
| sit reposapiés <i>footstool</i> | código <i>code</i> | m³ <i>m³</i> | kg <i>kg</i> | € | + |
| color pintura <i>painting colour</i> | 1223710-- | 0,45 | 23 | 685 | |
| funda impermeable <i>waterproof cover</i> | 122390025 | | | 170 | |

| | | | |
|---|------------------------------|----------|--|
| almohadón reposapiés <i>footstool cushion (seat)</i> | código <i>code</i> | € | Total chasis + alm as. € <i>Total frame + seat cush. €</i> |
| tejido A <i>A fabric</i> | 1223400-- | 675 | 1.360 |
| tejido B <i>B fabric</i> | 1223400-- | 685 | 1.370 |
| tejido C <i>C fabric</i> | 1223400-- | 750 | 1.435 |
| tejido D <i>D fabric</i> | 1223400-- | 785 | 1.470 |
| tejido cliente 137 cm.: <i>COM fabric 54"</i> : Largo 241 cm. <i>Length 94,88"</i> | 122340099 | 675 | 1.360 |

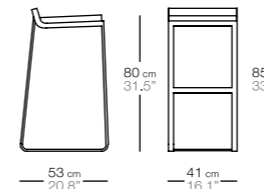

| | | | | | |
|---|------------------------------|--|------------------------|----------|----------|
| sit taburete con respaldo 78 <i>back rest barstool 78</i> | código <i>code</i> | m³ <i>m³</i> | kg <i>kg</i> | € | + |
| color pintura <i>painting colour</i> | 1217010-- | 0,24 | 5 | 560 | |
| funda impermeable <i>waterproof cover</i> | 121790025 | | | 170 | |

| | | | |
|--|------------------------------|----------|--|
| almohadón asiento <i>seat cushion</i> | código <i>code</i> | € | Total chasis + alm as. € <i>Total frame + seat cush. €</i> |
| tejido A <i>A fabric</i> | 1217500-- | 160 | 720 |
| tejido B <i>B fabric</i> | 1217500-- | 165 | 725 |
| tejido C <i>C fabric</i> | 1217500-- | 180 | 740 |
| tejido D <i>D fabric</i> | 1217500-- | 195 | 755 |
| tejido cliente 137 cm.: <i>COM fabric 54"</i> : Largo 45 cm. <i>Length 17,72"</i> | 121750099 | 160 | 720 |

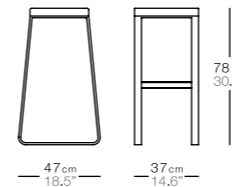

| | | | | | |
|--|------------------------------|--|------------------------|----------|----------|
| sit taburete 78 <i>barstool 78</i> | código <i>code</i> | m³ <i>m³</i> | kg <i>kg</i> | € | + |
| color pintura <i>painting colour</i> | 1214010-- | 0,16 | 9 | 415 | |
| funda impermeable <i>waterproof cover</i> | 121490025 | | | 170 | |

| | | | |
|--|------------------------------|----------|--|
| almohadón asiento <i>seat cushion</i> | código <i>code</i> | € | Total chasis + alm as. € <i>Total frame + seat cush. €</i> |
| tejido A <i>A fabric</i> | 1214500-- | 205 | 620 |
| tejido B <i>B fabric</i> | 1214500-- | 210 | 625 |
| tejido C <i>C fabric</i> | 1214500-- | 225 | 640 |
| tejido D <i>D fabric</i> | 1214500-- | 230 | 645 |
| tejido cliente 137 cm.: <i>COM fabric 54"</i> : Largo 35 cm. <i>Length 13,78"</i> | 121450099 | 205 | 620 |

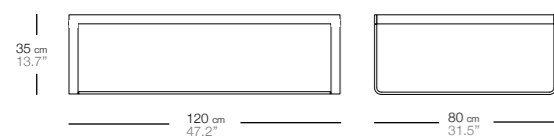

El sobre y las patas se sirven
desmontadas (2 cajas)
Table top and legs are delivered
unassembled (2 boxes)

sit mesa baja 120x80x35
low table 120x80x35

código
code

m³
m³

kg
kg

€

color pintura / sobre compact blanco
painting colour / white compact top

12603--50

0,62

25

1.210

color pintura / sobre aluminio pintado
painting colour / painted aluminum top

12603--/--

0,62

31

1.600

color pintura / lamas madera iroko
painting colour / iroko wood slats

12603--70

0,62

27

1.880

color pintura / sobre dekon
painting colour / dekon top

12603--/--

0,62

30

1.610

funda impermeable
waterproof cover

126096725

170

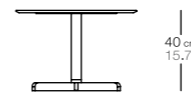

sit mesa pie central 40
central leg table 40

El sobre y las patas se sirven desmontadas
Table top and legs are delivered unassembled



Ø60x40h.
Ø23,6"x15,7"h.



60x60x40h.
23,6"x23,6"x15,7"h.

color pintura / sobre compact blanco
painting colour / white compact top

12651--50

m³
m³

kg
kg

€

700

código
code

12771--50

m³
m³

kg
kg

€

750

color pintura / sobre aluminio pintado
painting colour / painted aluminum top

12651--/--

0,25

7

850

12771--/--

0,25

8

850

color pintura / sobre madera iroko
painting colour / iroko wood top

12651--70

0,25

10

1.090

color pintura / sobre dekon
painting colour / dekon top

12651--/--

0,25

12

1.325

12771--/--

0,25

13

1.210

funda impermeable
waterproof cover

126598225

125

126598725

125

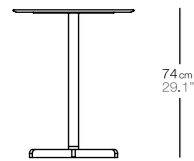

El sobre y las patas se sirven desmontadas
Table top and legs are delivered unassembled



Ø60x74h.
Ø23,6"x29,1"h

| | código code | m³ m³ | kg kg | € |
|--|-----------------------|-----------------|-----------------|----------|
| color pintura / sobre compact blanco painting colour / white compact top | 12652--50 | 0,51 | 13 | 765 |
| color pintura / sobre aluminio pintado painting colour / painted aluminum top | 12652--/-- | 0,51 | 9 | 930 |
| color pintura / sobre madera iroko painting colour / iroko top | 12652--70 | 0,51 | 14 | 1.185 |
| color pintura / sobre dektion painting colour / dekton top | 12652--/-- | 0,51 | 16 | 1.410 |
| funda impermeable waterproof cover | 126698225 | | | 170 |



60x60x74h.
23,6"x23,6"x29,1"h.

| | código code | m³ m³ | kg kg | € |
|--|-----------------------|-----------------|-----------------|----------|
| | 12772--50 | 0,51 | 14 | 765 |
| | 12772--/-- | 0,51 | 10 | 930 |
| | 12772--/-- | 0,51 | 17 | 1.220 |
| | 126698725 | | | 170 |



70x70x74h.
27,5"x27,5"x29,1"h.

| | código code | m³ m³ | kg kg | € |
|--|-----------------------|-----------------|-----------------|----------|
| color pintura / sobre compact blanco painting colour / white compact top | 12662--50 | 0,52 | 15 | 830 |
| color pintura / sobre aluminio pintado painting colour / painted aluminum top | 12662--/-- | 0,52 | 11 | 1.050 |
| color pintura / sobre dektion painting colour / dekton top | 12662--/-- | 0,52 | 18 | 1.385 |
| funda impermeable waterproof cover | 126698425 | | | 180 |



75x75x74h.
29,5"x29,5"x29,1"h.

| | código code | m³ m³ | kg kg | € |
|--|-----------------------|-----------------|-----------------|----------|
| | 12782--50 | 0,52 | 16 | 1.045 |
| | 12782--/-- | 0,52 | 12 | 1.280 |
| | 12782--/-- | 0,52 | 19 | 1.535 |
| | 126695825 | | | 180 |

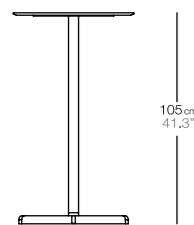

El sobre y las patas se sirven desmontadas
Table top and legs are delivered unassembled



Ø60x105h.
Ø23,6"x41,3"h

| | código code | m³ m³ | kg kg | € |
|--|-----------------------|-----------------|-----------------|----------|
| color pintura / sobre compact blanco painting colour / white compact top | 12653--50 | 0,63 | 14 | 795 |
| color pintura / sobre aluminio pintado painting colour / painted aluminum top | 12653--/-- | 0,63 | 12 | 1.045 |
| color pintura / sobre madera iroko painting colour / iroko top | 12653--70 | 0,63 | 15 | 1.175 |
| color pintura / sobre dektion painting colour / dekton top | 12653--/-- | 0,63 | 17 | 1.440 |
| funda impermeable waterproof cover | 126798225 | | | 225 |



60x60x105h.
23,6"x23,6"x41,3"h.

| | código code | m³ m³ | kg kg | € |
|--|-----------------------|-----------------|-----------------|----------|
| | 12773--50 | 0,63 | 15 | 795 |
| | 12773--/-- | 0,63 | 13 | 1.045 |
| | 12773--/-- | 0,63 | 18 | 1.270 |
| | 126798725 | | | 225 |



70x70x105h.
27,5"x27,5"x41,3"h.

| | código code | m³ m³ | kg kg | € |
|--|-----------------------|-----------------|-----------------|----------|
| color pintura / sobre compact blanco painting colour / white compact top | 12663--50 | 0,63 | 16 | 865 |
| color pintura / sobre aluminio pintado painting colour / painted aluminum top | 12663--/-- | 0,63 | 14 | 1.150 |
| color pintura / sobre dektion painting colour / dekton top | 12663--/-- | 0,63 | 19 | 1.415 |
| funda impermeable waterproof cover | 126798425 | | | 225 |

Colección de sofás fabricados con estructura de aluminio extruido y recubierto de pintura poliéster.

Almohadones: intercambiables.

Tejido acrílico: 100% acrílico teñido en masa, resistente a los rayos UVA (clasif. 7/8), tratamiento antimanchas y repelente al agua. Lavable a 30° C. Secado al aire libre.

Tejido vinytex: tejido sintético recubierto de poliéster. Resistente a los rayos UVA (clasif. 7/8). Lavable con jabón neutro diluido en una gran cantidad de agua. Funda impermeable: cubre asiento, respaldos y brazos altos.

Range of sofas manufactured with an extruded aluminium structure and final finish made with polyester powder coating.

Cushions: removable.

Acrylic fabric: 100% solution dyed acrylic, UV resistance (class. 7/8) with stain and water repellent finish. Washable at 30°C. Open air drying.

Vinytex fabric: synthetic fabric made of plastic coated polyester. UV resistance (class. 7/8). It is recommended to clean it with neutral soap diluted in large quantity of water. Waterproof cover: cover seat, backs and high armrests.

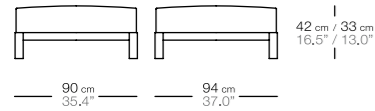

| nak XL S1 estructura nak XL S1 frame | alto (42 cm) high (42 cm) | | | | | | |
|---|------------------------------|----------------------------------|----------|-------|---|--|--|
| | código code | m ³ m ³ | kg kg | € | | | |
| color pintura painting colour | 0920710-- | 0,63 | 21 | 1.070 | | | |
| funda impermeable waterproof cover | 092099925 | | | 310 | + | | |

| nak XL 1 almohadón asiento nak XL 1 seat cushion | código code | € | Total chasis + alm as. € Total frame + seat cush. € |
|---|----------------|-----|--|
| tejido A A fabric | 1024410-- | 610 | 1.680 |
| tejido B B fabric | 1024410-- | 620 | 1.690 |
| tejido C C fabric | 1024410-- | 680 | 1.750 |
| tejido D D fabric | 1024410-- | 725 | 1.795 |
| tejido cliente 137 cm.: COM fabric 54": | 102441099 | 610 | 1.680 |
| Largo 245 cm. Length 96,46" | | | |

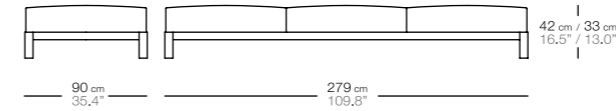

| nak XL S3 estructura nak XL S3 frame | alto (42 cm) high (42 cm) | | | | | | |
|---|------------------------------|----------------------------------|----------|-------|---|--|--|
| | código code | m ³ m ³ | kg kg | € | | | |
| color pintura painting colour | 0922710-- | 1,83 | 53 | 2.370 | | | |
| funda impermeable waterproof cover | 092299925 | | | 455 | + | | |

| nak XL 3 almohadones asiento nak XL 3 seat cushions | código code | € | Total chasis + alm as. € Total frame + seat cush. € |
|--|----------------|-------|--|
| tejido A A fabric | 1024415-- | 1.830 | 4.200 |
| tejido B B fabric | 1024415-- | 1.860 | 4.230 |
| tejido C C fabric | 1024415-- | 2.040 | 4.410 |
| tejido D D fabric | 1024415-- | 2.175 | 4.545 |
| tejido cliente 137 cm.: COM fabric 54": | 102441599 | 1.830 | 4.200 |
| Largo 735 cm. Length 289,37" | | | |

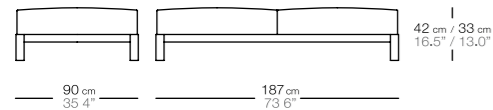

| nak XL S2 estructura nak XL S2 frame | alto (42 cm) high (42 cm) | | | | | | |
|---|------------------------------|----------------------------------|----------|-------|---|--|--|
| | código code | m ³ m ³ | kg kg | € | | | |
| color pintura painting colour | 0921710-- | 1,23 | 33 | 1.575 | | | |
| funda impermeable waterproof cover | 092199925 | | | 380 | + | | |

| nak XL 2 almohadones asiento nak XL 2 seat cushions | código code | € | Total chasis + alm as. € Total frame + seat cush. € |
|--|----------------|-------|--|
| tejido A A fabric | 1024414-- | 1.220 | 2.795 |
| tejido B B fabric | 1024414-- | 1.240 | 2.815 |
| tejido C C fabric | 1024414-- | 1.360 | 2.935 |
| tejido D D fabric | 1024414-- | 1.450 | 3.025 |
| tejido cliente 137 cm.: COM fabric 54": | 102441499 | 1.220 | 2.795 |
| Largo 490 cm. Length 192,91" | | | |

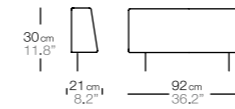

| nak XL almohadón respaldo nak XL backrest cushion | código code | kg kg | € |
|--|----------------|----------|-----|
| tejido A A fabric | 0920711-- | 2,8 | 425 |
| tejido B B fabric | 0920711-- | 2,8 | 435 |
| tejido C C fabric | 0920711-- | 2,8 | 475 |
| tejido D D fabric | 0920711-- | 2,8 | 520 |
| tejido cliente 137 cm.: COM fabric 54": | 092071199 | 2,8 | 425 |
| Largo 130 cm. Length 51,18" | | | |

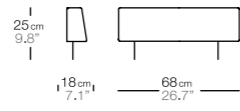
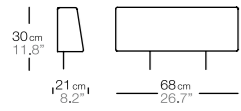

| nak almohadón resp. esquinero <i>nak back corner cushion</i> | código <i>code</i> | kg <i>kg</i> | € |
|---|-----------------------|-----------------|-----|
| tejido A <i>A fabric</i> | 0920612-- | 1,5 | 370 |
| tejido B <i>B fabric</i> | 0920612-- | 1,5 | 385 |
| tejido C <i>C fabric</i> | 0920612-- | 1,5 | 405 |
| tejido D <i>D fabric</i> | 0920612-- | 1,5 | 435 |
| tejido cliente 137 cm.: <i>COM fabric 54"</i> : | 092061299 | 1,5 | 370 |
| Largo 105 cm. <i>Length 41,34"</i> | | | |

| nak almohadón brazo <i>nak armrest cushion</i> | código <i>code</i> | kg <i>kg</i> | € |
|--|-----------------------|-----------------|-----|
| tejido A <i>A fabric</i> | 0920613-- | 1,4 | 355 |
| tejido B <i>B fabric</i> | 0920613-- | 1,4 | 370 |
| tejido C <i>C fabric</i> | 0920613-- | 1,4 | 405 |
| tejido D <i>D fabric</i> | 0920613-- | 1,4 | 430 |
| tejido cliente 137 cm.: <i>COM fabric 54"</i> : | 092061399 | 1,4 | 355 |
| Largo 85 cm. <i>Length 33,46"</i> | | | |

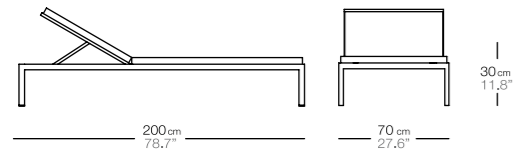

| nak tumbona <i>deckchair</i> | sin ruedas <i>no wheels</i> | código <i>code</i> | m ³ <i>m³</i> | kg <i>kg</i> | € |
|--|--------------------------------|-----------------------|--|-----------------|---|
| color pintura <i>painting colour</i> | 0930310-- | 0,70 | 24 | 1.300 | + |
| funda impermeable <i>waterproof cover</i> | 093190025 | | | 310 | |

| almohadón asiento, respaldo <i>seat, back cushion</i> | código <i>code</i> | € | Total chasis + alm. as. + resp. € <i>Total frame + seat cush. + back cush. €</i> |
|--|-----------------------|-------|---|
| tejido A <i>A fabric</i> | 0931500-- | 870 | 2.170 |
| tejido B <i>B fabric</i> | 0931500-- | 905 | 2.205 |
| tejido C <i>C fabric</i> | 0931500-- | 1.010 | 2.310 |
| tejido D <i>D fabric</i> | 0931500-- | 1.090 | 2.390 |
| tejido cliente 137 cm.: <i>COM fabric 54"</i> : | 093150099 | 870 | 2.170 |
| Largo 400 cm. <i>Length 157,48"</i> | | | |

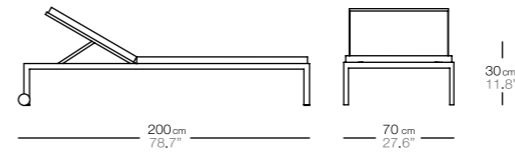

| nak tumbona <i>deckchair</i> | con ruedas <i>with wheels</i> | código <i>code</i> | m ³ <i>m³</i> | kg <i>kg</i> | € | + | almohadón asiento, respaldo <i>seat, back cushion</i> | código <i>code</i> | € | Total chasis + alm. as. + resp. € <i>Total frame + seat cush. + back cush. €</i> |
|--|----------------------------------|-----------------------|--|-----------------|---|---|--|-----------------------|-------|---|
| color pintura <i>painting colour</i> | 0931310-- | 0,70 | 24 | 1.415 | | | tejido A <i>A fabric</i> | 0931500-- | 870 | 2.285 |
| funda impermeable <i>waterproof cover</i> | 93190025 | | | 310 | | | tejido B <i>B fabric</i> | 0931500-- | 905 | 2.320 |
| | | | | | | | tejido C <i>C fabric</i> | 0931500-- | 1.010 | 2.425 |
| | | | | | | | tejido D <i>D fabric</i> | 0931500-- | 1.090 | 2.505 |
| | | | | | | | tejido cliente 137 cm.: <i>COM fabric 54"</i> : | 093150099 | 870 | 2.285 |
| Largo 400 cm. <i>Length 157,48"</i> | | | | | | | | | | |

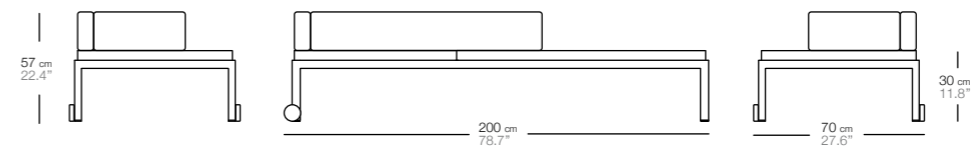

| nak tumbona day & night <i>(incluye 2 alm. respaldos + 1 alm. brazo, ruedas)</i> <i>nak day & night deckchair (2 back rest + 1 armrest chushion included, wheels)</i> | código <i>code</i> | m ³ <i>m³</i> | kg <i>kg</i> | € | + | almohadón asiento, 2 respaldos, 1 brazo <i>seat, 2 back cushion, 1 armrest cushion</i> | código <i>code</i> | € | Total chasis + alm. as. + resp. € <i>Total frame + seat cush. + back cush. €</i> |
|---|-----------------------|--|-----------------|-------|---|--|-----------------------|-------|---|
| color pintura <i>painting colour</i> | 0918510-- | 0,70 | 29 | 1.935 | | tejido A <i>A fabric</i> | 0918400-- | 1.715 | 3.650 |
| funda impermeable <i>waterproof cover</i> | 091890025 | | | 375 | | tejido B <i>B fabric</i> | 0918400-- | 1.765 | 3.700 |
| | | | | | | tejido C <i>C fabric</i> | 0918400-- | 1.980 | 3.915 |
| | | | | | | tejido D <i>D fabric</i> | 0918400-- | 2.145 | 4.080 |
| | | | | | | tejido cliente 137 cm.: <i>COM fabric 54"</i> : | 091840099 | 1.715 | 3.650 |
| Largo 595 cm. <i>Length 234,25"</i> | | | | | | | | | |

Nak 65

Colección de sofás fabricados con estructura de aluminio extruido y recubierto de pintura poliéster.

Tejido acrílico: 100% acrílico teñido en masa, resistente a los rayos UVA (clasif. 7/8), tratamiento antimanchas y repelente al agua.

Lavable a 30° C. Secado al aire libre.

Tejido vinytex: tejido sintético recubierto de poliéster. Resistente a los rayos UVA (clasif. 7/8). Lavable con jabón neutro diluido en una gran cantidad de agua.

Range of sofas manufactured with an extruded aluminium structure and final finish made with polyester powder coating.

Acrylic fabric: 100% solution dyed acrylic, UV resistance (class. 7/8) with stain and water repellent finish. Washable at 30°C. Open air drying.

Vinytex fabric: synthetic fabric made of plastic coated polyester.

UV resistance (class. 7/8). It is recommended to clean it with neutral soap diluted in large quantity of water.

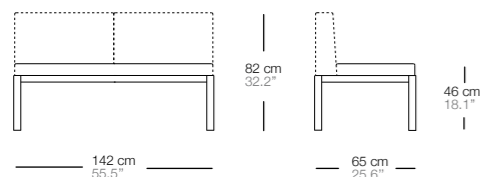

nak 65 S2
nak 65 S2

comedor (46 cm)
dining (46 cm)

| | código code | m ³ m ³ | kg kg | € |
|---------------------------------------|----------------|----------------------------------|----------|-------|
| color pintura painting colour | 2121010-- | 1,7 | 39 | 1.050 |
| funda impermeable waterproof cover | 212190025 | | | 380 |

| | código code | € | Total chasis + alm as. € Total frame + seat cush. € |
|---|----------------|-----|--|
| + nak 65 S2 almohadón asiento (no alm. respaldo esquinero) nak 65 S2 seat cushion (no back corner cushion) | | | |
| tejido A A fabric | 2121500-- | 620 | 1.670 |
| tejido B B fabric | 2121500-- | 630 | 1.680 |
| tejido C C fabric | 2121500-- | 660 | 1.710 |
| tejido D D fabric | 2121500-- | 695 | 1.745 |
| tejido cliente 137 cm.: COM fabric 54": Largo 144 cm. Length 56,70" | 212150099 | 620 | 1.670 |
| + nak 65 S2 almohadón asiento (1 alm. resp. esquinero) nak 65 S2 seat cushion (1 back corner cush.) | | | |
| tejido A A fabric | 2121600-- | 600 | 1.650 |
| tejido B B fabric | 2121600-- | 615 | 1.665 |
| tejido C C fabric | 2121600-- | 660 | 1.710 |
| tejido D D fabric | 2121600-- | 690 | 1.740 |
| tejido cliente 137 cm.: COM fabric 54": Largo 133 cm. Length 52,37" | 212160099 | 600 | 1.650 |
| + nak 65 S2 almohadón asiento (2 alm. resp. esquinero) nak 65 S2 seat cushion (2 back corner cush.) | | | |
| tejido A A fabric | 2121700-- | 545 | 1.595 |
| tejido B B fabric | 2121700-- | 560 | 1.610 |
| tejido C C fabric | 2121700-- | 595 | 1.645 |
| tejido D D fabric | 2121700-- | 625 | 1.675 |
| tejido cliente 137 cm.: COM fabric 54": Largo 122 cm. Length 48,03" | 212170099 | 545 | 1.595 |

Nak 65

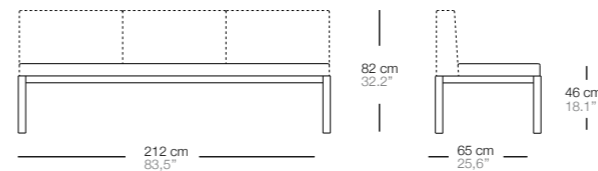

nak 65 S3
nak 65 S3

comedor (46 cm)
dining (46 cm)

| | código code | m ³ m ³ | kg kg | € |
|---------------------------------------|----------------|----------------------------------|----------|-------|
| color pintura painting colour | 2122010-- | 2,53 | 52 | 1.390 |
| funda impermeable waterproof cover | 212290025 | | | 455 |

| | código code | € | Total chasis + alm as. € Total frame + seat cush. € |
|---|----------------|-----|--|
| + nak 65 S3 almohadón asiento (no alm. respaldo esquinero) nak 65 S3 seat cushion (no back corner cushion) | | | |
| tejido A A fabric | 2122500-- | 800 | 2.190 |
| tejido B B fabric | 2122500-- | 815 | 2.205 |
| tejido C C fabric | 2122500-- | 875 | 2.265 |
| tejido D D fabric | 2122500-- | 920 | 2.310 |
| tejido cliente 137 cm.: COM fabric 54": Largo 202 cm. Length 79,53" | 212250099 | 800 | 2.190 |
| + nak 65 S3 almohadón asiento (1 alm. resp. esquinero) nak 65 S3 seat cushion (1 back corner cush.) | | | |
| tejido A A fabric | 2122600-- | 730 | 2.120 |
| tejido B B fabric | 2122600-- | 745 | 2.135 |
| tejido C C fabric | 2122600-- | 800 | 2.190 |
| tejido D D fabric | 2122600-- | 845 | 2.235 |
| tejido cliente 137 cm.: COM fabric 54": Largo 190 cm. Length 74,8" | 212260099 | 730 | 2.120 |
| + nak 65 S3 almohadón asiento (2 alm. resp. esquinero) nak 65 S3 seat cushion (2 back corner cush.) | | | |
| tejido A A fabric | 2122700-- | 715 | 2.105 |
| tejido B B fabric | 2122700-- | 735 | 2.125 |
| tejido C C fabric | 2122700-- | 785 | 2.175 |
| tejido D D fabric | 2122700-- | 825 | 2.215 |
| tejido cliente 137 cm.: COM fabric 54": Largo 176 cm. Length 69,29" | 212270099 | 715 | 2.105 |

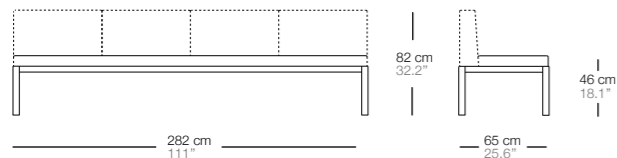

nak 65 S4
nak 65 S4

comedor (46 cm)
dining (46 cm)

| | código code | m³ m ³ | kg kg | € |
|---------------------------------------|-----------------------|--|-----------------|----------|
| color pintura painting colour | 2136010-- | 2,52 | 65 | 1.840 |
| funda impermeable waterproof cover | 213690025 | | | 510 |

| + | nak 65 S4 almohadón asiento (no alm. respaldo esquinero) nak 65 S4 seat cushion (no back corner cushion) | código code | € | Total chasis + alm as. € Total frame + seat cush. € |
|----------|--|-----------------------|----------|---|
| | tejido A A fabric | 2136500-- | 1.010 | 2.850 |
| | tejido B B fabric | 2136500-- | 1.035 | 2.875 |
| | tejido C C fabric | 2136500-- | 1.120 | 2.960 |
| | tejido D D fabric | 2136500-- | 1.185 | 3.025 |
| | tejido cliente 137 cm.: COM fabric 54": | 213650099 | 1.010 | 2.850 |
| | Largo 282 cm. Length 111" | | | |
| + | nak 65 S4 almohadón asiento (1 alm. resp. esquinero) nak 65 S4 seat cushion (1 back corner cush.) | código code | € | Total chasis + alm as. € Total frame + seat cush. € |
| | tejido A A fabric | 2136600-- | 970 | 2.810 |
| | tejido B B fabric | 2136600-- | 990 | 2.830 |
| | tejido C C fabric | 2136600-- | 1.070 | 2.910 |
| | tejido D D fabric | 2136600-- | 1.130 | 2.970 |
| | tejido cliente 137 cm.: COM fabric 54": | 213660099 | 970 | 2.810 |
| | Largo 250 cm. Length 98,43" | | | |
| + | nak 65 S4 almohadón asiento (2 alm. resp. esquinero) nak 65 S4 seat cushion (2 back corner cush.) | código code | € | Total chasis + alm as. € Total frame + seat cush. € |
| | tejido A A fabric | 2136700-- | 960 | 2.800 |
| | tejido B B fabric | 2136700-- | 975 | 2.815 |
| | tejido C C fabric | 2136700-- | 1.025 | 2.865 |
| | tejido D D fabric | 2136700-- | 1.085 | 2.925 |
| | tejido cliente 137 cm.: COM fabric 54": | 213670099 | 960 | 2.800 |
| | Largo 235 cm. Length 92,52" | | | |

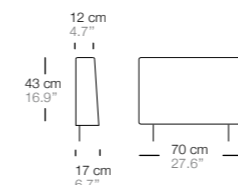

nak 65 almohadón respaldo
nak 65 backrest cushion

| | código code | € |
|--|-----------------------|----------|
| tejido A A fabric | 2120400-- | 475 |
| tejido B B fabric | 2120400-- | 485 |
| tejido C C fabric | 2120400-- | 510 |
| tejido D D fabric | 2120400-- | 540 |
| tejido cliente 137 cm.: COM fabric 54": | 212040099 | 475 |
| Largo 102 cm. Length 40,31" | | |

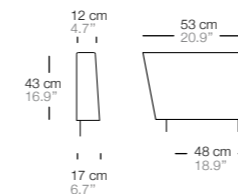

nak 65 almohadón resp. esquinero izq.
nak 65 left back corner cushion

| | código code | € |
|--|-----------------------|----------|
| tejido A A fabric | 2120601-- | 435 |
| tejido B B fabric | 2120601-- | 445 |
| tejido C C fabric | 2120601-- | 465 |
| tejido D D fabric | 2120601-- | 495 |
| tejido cliente 137 cm.: COM fabric 54": | 212060199 | 435 |
| Largo 79 cm. Length 31,11" | | |

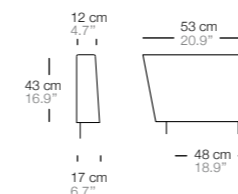

nak 65 almohadón resp. esquinero der.
nak 65 right back corner cushion

| | código code | € |
|--|-----------------------|----------|
| tejido A A fabric | 2120602-- | 435 |
| tejido B B fabric | 2120602-- | 445 |
| tejido C C fabric | 2120602-- | 465 |
| tejido D D fabric | 2120602-- | 495 |
| tejido cliente 137 cm.: COM fabric 54": | 212060299 | 435 |
| Largo 79 cm. Length 31,11" | | |

Sistema modular de sofás apto para el exterior y fabricado con el sistema Screen Cover, exclusivo de Bivaq. A través de este sistema se ha desarrollado un mueble tapizado con las prestaciones necesarias para usarlo en el exterior. Estructura de tubo de aluminio cubierto con tejido vinytex.

Tejido acrílico: 100% acrílico teñido en masa, resistente a los rayos UVA (clasif. 7/8), tratamiento antimanchas y repelente al agua. Lavable a 30° C. Secado al aire libre.

Tejido vinytex: tejido sintético recubierto de poliéster. Resistente a los rayos UVA (clasif. 7/8). Lavable con jabón neutro diluido en una gran cantidad de agua.

Modular system of sofas, suitable for outside and manufactured with the Screen Cover system, exclusive from Bivaq. By this system, upholstered furniture has been developed with the features necessary for using it outdoors. Sofa structure made of aluminium tube covered with vinytex fabric.

Acrylic fabric: 100% solution dyed acrylic, UV resistance (class. 7/8) with stain and water repellent finish. Washable at 30°C. Open air drying.
Vinytex fabric: synthetic fabric made of plastic coated polyester. UV resistance (class. 7/8). It is recommended to clean it with neutral soap diluted in large quantity of water.

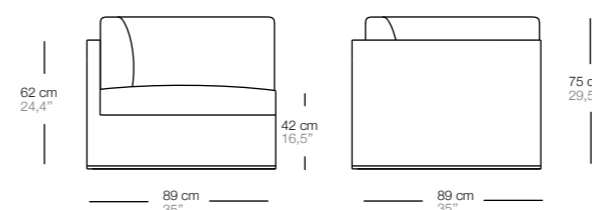
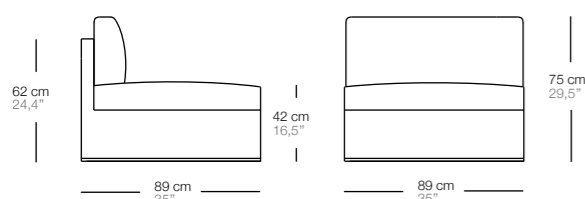

mood xl modulo central
centre module

| | código <i>code</i> | m³ <i>m³</i> | kg <i>kg</i> | € | + | almohadón módulo (asiento, respaldo) <i>module cushion (seat, back)</i> | código <i>code</i> | € | Total chasis + alm as. + resp. € <i>Total frame + seat cush. + back cush. €</i> |
|--|------------------------------|--|------------------------|----------|----------|---|------------------------------|----------|---|
| tejido A <i>A fabric</i> | 23243--/-- | 0,73 | 30 | 2.160 | | | | | |
| tejido B <i>B fabric</i> | 23243--/-- | 0,73 | 30 | 2.195 | | | | | |
| tejido C <i>C fabric</i> | 23243--/-- | 0,73 | 30 | 2.320 | | tejido A <i>A fabric</i> | 2324400-- | 730 | 2.890 |
| tejido D <i>D fabric</i> | 23243--/-- | 0,73 | 30 | 2.405 | | tejido B <i>B fabric</i> | 2324400-- | 750 | 2.945 |
| tejido cliente 137 cm.: <i>COM fabric 54"</i> : | 23243--99 | 0,73 | 30 | 2.160 | | tejido C <i>C fabric</i> | 2324400-- | 850 | 3.170 |
| Largo 280 cm. <i>Length 110,24"</i> | | | | | | tejido D <i>D fabric</i> | 2324400-- | 920 | 3.325 |
| funda impermeable <i>waterproof cover</i> | 232490025 | | | 310 | | tejido cliente 137 cm.: <i>COM fabric 54"</i> : | 232440099 | 730 | 2.890 |
| | | | | | | Largo 295 cm. <i>Length 116,14"</i> | | | |

mood xl modulo esquinero
corner module

| | código <i>code</i> | m³ <i>m³</i> | kg <i>kg</i> | € | + | almohadón módulo esquinero (1 asiento, 2 respaldos) <i>corner module cushion (1 seat, 2 backs)</i> | código <i>code</i> | € | Total chasis + alm as. + resp. € <i>Total frame + seat cush. + back cush. €</i> |
|--|------------------------------|--|------------------------|----------|----------|--|------------------------------|----------|---|
| tejido A <i>A fabric</i> | 23273--/-- | 0,73 | 31 | 2.340 | | | | | |
| tejido B <i>B fabric</i> | 23273--/-- | 0,73 | 31 | 2.390 | | | | | |
| tejido C <i>C fabric</i> | 23273--/-- | 0,73 | 31 | 2.550 | | tejido A <i>A fabric</i> | 2327400-- | 895 | 3.235 |
| tejido D <i>D fabric</i> | 23273--/-- | 0,73 | 31 | 2.650 | | tejido B <i>B fabric</i> | 2327400-- | 920 | 3.310 |
| tejido cliente 137 cm.: <i>COM fabric 54"</i> : | 23273--99 | 0,73 | 31 | 2.340 | | tejido C <i>C fabric</i> | 2327400-- | 1.045 | 3.595 |
| Largo 380 cm. <i>Length 149,61"</i> | | | | | | tejido D <i>D fabric</i> | 2327400-- | 1.140 | 3.790 |
| funda impermeable <i>waterproof cover</i> | 232790025 | | | 310 | | tejido cliente 137 cm.: <i>COM fabric 54"</i> : | 232740099 | 895 | 3.235 |
| | | | | | | Largo 370 cm. <i>Length 145,67"</i> | | | |

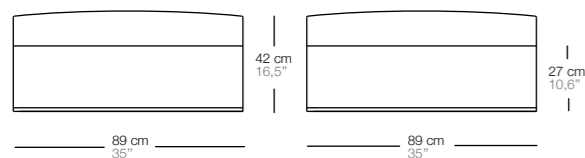

mood xl modulo reposapiés
footstool module

| | código code | m³ m ³ | kg kg | € | + | almohadón módulo reposapiés (asiento) footstool module cushion (seat) | código code | € | Total chasis + alm. as. € Total frame + seat cush. € |
|--|-----------------------|--|-----------------|----------|----------|---|-----------------------|----------|--|
| tejido A A fabric | 23233--/-- | 0,52 | 24 | 1.635 | | | | | |
| tejido B B fabric | 23233--/-- | 0,52 | 24 | 1.665 | | tejido A A fabric | 2323400-- | 505 | 2.140 |
| tejido C C fabric | 23233--/-- | 0,52 | 24 | 1.755 | | tejido B B fabric | 2323400-- | 520 | 2.185 |
| tejido D D fabric | 23233--/-- | 0,52 | 24 | 1.830 | | tejido C C fabric | 2323400-- | 585 | 2.340 |
| tejido cliente 137 cm.: COM fabric 54": | 23233--99 | 0,52 | 24 | 1.635 | | tejido D D fabric | 2323400-- | 630 | 2.460 |
| Largo 265 cm. Length 104,33" | | | | | | tejido cliente 137 cm.: COM fabric 54": | 232340099 | 505 | 2.140 |
| funda impermeable waterproof cover | 232390025 | | | 170 | | Largo 220 cm. Length 86,61" | | | |

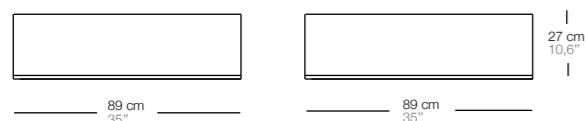

mood xl modulo mesa baja
(incluye cristal transparente)
low table module
(transparent glass included)

| | código code | m³ m ³ | kg kg | € |
|--|-----------------------|--|-----------------|----------|
| tejido A A fabric | 23703--/-- | 0,47 | 22 | 1.900 |
| tejido B B fabric | 23703--/-- | 0,47 | 22 | 1.930 |
| tejido C C fabric | 23703--/-- | 0,47 | 22 | 2.020 |
| tejido D D fabric | 23703--/-- | 0,47 | 22 | 2.090 |
| tejido cliente 137 cm.: COM fabric 54": | 237030099 | 0,47 | 22 | 1.900 |
| Largo 265 cm. Length 104,33" | | | | |
| funda impermeable waterproof cover | 237090025 | | | 170 |

Sistema modular de sofás fabricados con estructura de aluminio extruido y recubierto de pintura poliéster.
Tejido acrílico: 100% acrílico teñido en masa, resistente a los rayos UVA (clasif. 7/8), tratamiento antimanchas y repelente al agua. Lavable a 30° C. Secado al aire libre.
Tejido vinytex: tejido sintético recubierto de poliéster. Resistente a los rayos UVA (clasif. 7/8). Lavable con jabón neutro diluido en una gran cantidad de agua.

Modular system of sofas manufactured with an extruded aluminium structure and final finish made with polyester powder coating.
Acrylic fabric: 100% solution dyed acrylic, UV resistance (class. 7/8) with stain and water repellent finish. Washable at 30° C. Open air drying.
Vinytex fabric: synthetic fabric made of plastic coated polyester. UV resistance (class. 7/8). It is recommended to clean it with neutral soap diluted in large quantity of water.

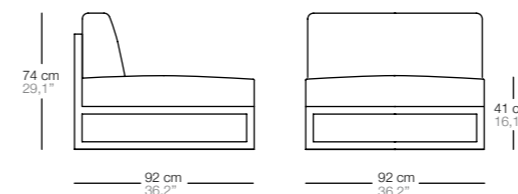

| nude modulo central centre module | código code | m³ m ³ | kg kg | € | + | almohadón módulo central (asiento, respaldo) centre module cushion (seat, back) | código code | € | Total chasis + alm. as. + resp. € Total frame + seat cush. + back cush. € |
|---|-----------------------|--|-----------------|----------|----------|---|-----------------------|----------|---|
| color pintura painting colour | 1524310-- | 0,75 | 33 | 1.080 | | | | | |
| funda impermeable waterproof cover | 152490025 | | | 310 | | tejido A A fabric | 0824400-- | 940 | 2.020 |
| | | | | | | tejido B B fabric | 0824400-- | 980 | 2.060 |
| | | | | | | tejido C C fabric | 0824400-- | 1.095 | 2.175 |
| | | | | | | tejido D D fabric | 0824400-- | 1.165 | 2.245 |
| | | | | | | tejido cliente 137 cm.: COM fabric 54": | 082440099 | 940 | 2.020 |
| | | | | | | Largo 370 cm. Length 145,67" | | | |

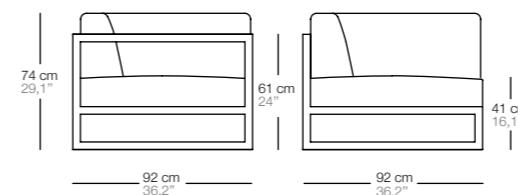

| nude modulo esquinero corner module | código code | m³ m ³ | kg kg | € | + | almohadón módulo esquinero (1 asiento, 2 respaldos) corner module cushion (1 seat, 2 backs) | código code | € | Total chasis + alm. as. + resp. € Total frame + seat cush. + back cush. € |
|---|-----------------------|--|-----------------|----------|----------|---|-----------------------|----------|---|
| color pintura painting colour | 1527310-- | 0,75 | 38 | 1.170 | | | | | |
| funda impermeable waterproof cover | 152790025 | | | 310 | | tejido A A fabric | 0827400-- | 1.110 | 2.280 |
| | | | | | | tejido B B fabric | 0827400-- | 1.135 | 2.305 |
| | | | | | | tejido C C fabric | 0827400-- | 1.300 | 2.470 |
| | | | | | | tejido D D fabric | 0827400-- | 1.415 | 2.585 |
| | | | | | | tejido cliente 137 cm.: COM fabric 54": | 082740099 | 1.110 | 2.280 |
| | | | | | | Largo 470 cm. Length 185,04" | | | |

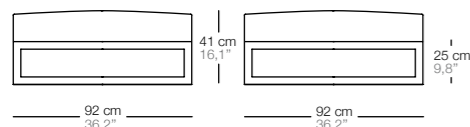

| nude modulo reposapiés footstool module | código code | m ³ m ³ | kg kg | € | almohadón módulo reposapiés (asiento) footstool module cushion (seat) | código code | € | Total chasis + alm as. + resp. € Total frame + seat cush. + back cush. € | |
|--|----------------|----------------------------------|----------|-----|--|--|-----------|---|-------|
| color pintura painting colour | 1523310-- | 0,62 | 27 | 895 | | | | | |
| funda impermeable waterproof cover | 152390025 | | | 170 | | | | | |
| | | | | | + | tejido A A fabric | 0823400-- | 675 | 1.570 |
| | | | | | | tejido B B fabric | 0823400-- | 685 | 1.580 |
| | | | | | | tejido C C fabric | 0823400-- | 750 | 1.645 |
| | | | | | | tejido D D fabric | 0823400-- | 785 | 1.680 |
| | | | | | | tejido cliente 137 cm.: COM fabric 54": | 082340099 | 675 | 1.570 |
| | | | | | | Largo 265 cm. Length 104,33" | | | |

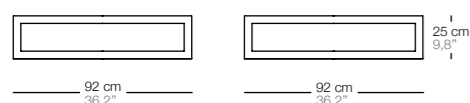

| nude modulo mesa baja low table module | código code | m ³ m ³ | kg kg | € |
|--|----------------|----------------------------------|----------|-------|
| color pintura / sobre compact blanco painting colour / white compact top | 15750--50 | 0,47 | 25 | 1.185 |
| color pintura / sobre aluminio pintado painting colour / painted aluminum top | 15750--/-- | 0,47 | 22 | 1.670 |
| color pintura / lamas madera iroko painting colour / iroko wood slats | 15750--70 | 0,47 | 26 | 1.750 |
| color pintura / sobre dekon painting colour / dekon top | 15750--/-- | 0,47 | 28 | 1.625 |
| funda impermeable waterproof cover | 157090025 | | | 170 |

Estructura de aluminio extruido y acabado con pintura poliéster.

Silla y tumbona apilable. Hamaca plegable.

Tejido vinytex: tejido sintético recubierto de poliéster.

Structure made of extruded aluminium and final finish made with polyester powder coating. Stackable chair and deckchair. Folding hammock.

Vinytex fabric: synthetic fabric made of plastic coated polyester.

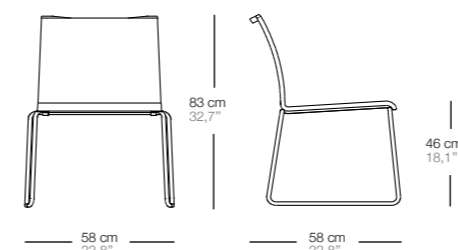

club silla
chair

pintura aluminio
aluminium painting

vinytex
vinytex

código
code

m³
m³

kg
kg

€

blanco textura
texture white

white sun
white sun

031102211

0,45

5,5

455

grafito antracita
grafito antracita

black antracita
black antracita

031105410

0,45

5,5

455

funda impermeable
waterproof cover

031190025

230

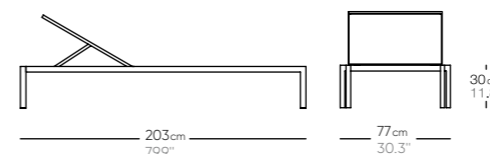

La tumbona Club está disponible en 3 versiones:

- sin colchoneta
- con colchoneta standard (3,5 grosor)
- con colchoneta plus (8,5 cm grosor)

The Club deckchair is available in 3 versions:

- without pad cushion
- with standard pad cushion (1,37" thick)
- with plus pad cushion (3,34" thick)

club tumbona
deckchair

sin ruedas
no wheels

pintura aluminio
aluminium painting

código
code

m³
m³

kg
kg

€

+

color pintura / tejido (solo vinytex slings)
painting colour / fabric (only slings vinytex)

03303--/--

0,78

18

1.115

tejido A
A fabric

0382000--

535

1.650

funda impermeable
waterproof cover

033090025

310

tejido B
B fabric

0382000--

570

1.685

tejido C
C fabric

0382000--

675

1.790

tejido D
D fabric

0382000--

760

1.875

tejido cliente 137 cm.:
COM fabric 54":

038200099

535

1.650

Largo 315 cm.
Length 124"

colchoneta
plus grosor
8,5 cm
plus pad
cushion thick
3,34"

€

Total chasis
+ colchoneta €
Total frame
+ pad cush. €

+

tejido A
A fabric

0382500--

915

2.030

tejido B
B fabric

0382500--

955

2.070

tejido C
C fabric

0382500--

1.065

2.180

tejido D
D fabric

0382500--

1.145

2.260

tejido cliente 137 cm.:
COM fabric 54":

038250099

915

2.030

Largo 345 cm.
Length 136"

*CÓDIGOS COLORES PINTURA, TEJIDOS y SOBRES MESA. Ver páginas 64-65.

*PAINTING COLORS CODES, FABRICS and TABLE TOPS. See pages 64-65.

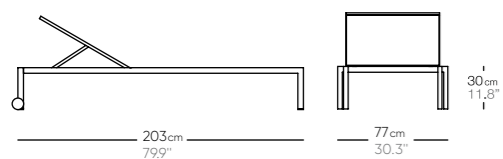

La tumbona Club está disponible en 3 versiones:

- sin colchoneta
- con colchoneta standard (3,5 grosor)
- con colchoneta plus (8,5 cm grosor)

The Club deckchair is available in 3 versions:

- without pad cushion
- with standard pad cushion (1,37" thick)
- with plus pad cushion (3,34" thick)

club tumbona
deckchair

con ruedas
with wheels

pintura aluminio
aluminium painting

código
code

m³
m³

kg
kg

€

color pintura / tejido (solo vinytex slings)
painting colour / fabric (only slings vinytex)

03313--/--

0,78 19 1.355

+

tejido A
A fabric

0382000--

535 1.890

funda impermeable
waterproof cover

033090025

310

tejido B
B fabric

0382000--

570 1.925

tejido C
C fabric

0382000--

675 2.030

tejido D
D fabric

0382000--

760 2.115

tejido cliente 137 cm.:
COM fabric 54":

038200099

535 1.890

Largo 315 cm.
Length 124"

colchoneta
plus grosor
8,5 cm
plus pad
cushion thick
3,34"

€ Total chasis
+ colchoneta €
Total frame
+ pad cush. €

+

tejido A
A fabric

0382500--

915 2.270

tejido B
B fabric

0382500--

955 2.310

tejido C
C fabric

0382500--

1.065 2.420

tejido D
D fabric

0382500--

1.145 2.500

tejido cliente 137 cm.:
COM fabric 54":

038250099

915 2.270

Largo 345 cm.
Length 136"

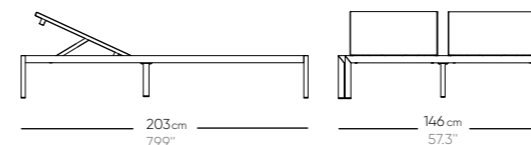

La tumbona Club está disponible en 3 versiones:

- sin colchoneta
- con colchoneta standard (3,5 grosor)
- con colchoneta plus (8,5 cm grosor)

The Club deckchair is available in 3 versions:

- without pad cushion
- with standard pad cushion (1,37" thick)
- with plus pad cushion (3,34" thick)

club tumbona doble
double deckchair

sin ruedas
no wheels

pintura aluminio
aluminium painting

código
code

m³
m³

kg
kg

€

color pintura / tejido (solo vinytex slings)
painting colour / fabric (only slings vinytex)

03353--/--

1,48 27 2.345

+

tejido A
A fabric

0335500--

1.005 3.350

tejido B
B fabric

0335500--

1.070 3.415

tejido C
C fabric

0335500--

1.290 3.635

tejido D
D fabric

0335500--

1.420 3.765

tejido cliente 137 cm.:
COM fabric 54":

033550099

1.005 3.350

Largo 571 cm.
Length 225"

colchoneta
plus grosor
8,5 cm
plus pad
cushion thick
3,34"

€ Total chasis
+ colchoneta €
Total frame
+ pad cush. €

+

tejido A
A fabric

0335600--

1.135 3.480

tejido B
B fabric

0335600--

1.165 3.510

tejido C
C fabric

0335600--

1.355 3.700

tejido D
D fabric

0335600--

1.510 3.855

tejido cliente 137 cm.:
COM fabric 54":

033560099

1.135 3.480

Largo 615 cm.
Length 242"

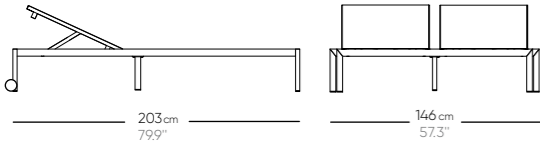

La tumbona Club está disponible en 3 versiones:

- sin colchoneta
- con colchoneta standard (3,5 grosor)
- con colchoneta plus (8,5 cm grosor)

The Club deckchair is available in 3 versions:

- without pad cushion
- with standard pad cushion (1,37" thick)
- with plus pad cushion (3,34" thick)

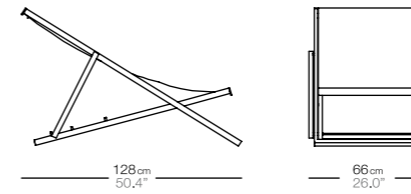

club tumbona doble
double deckchair

con ruedas
with wheels

pintura aluminio
aluminium painting

código
code

m³
m³

kg
kg

€

+

tejido A
A fabric

0335500--

1.005

3.590

tejido B
B fabric

0335500--

1.070

3.655

tejido C
C fabric

0335500--

1.290

3.875

tejido D
D fabric

0335500--

1.420

4.005

tejido cliente 137 cm.:
COM fabric 54":

033550099

1.005

3.590

Largo 571 cm.
Length 225"

colchoneta
plus grosor
8,5 cm
plus pad
cushion thick
3,34"

€

Total chasis
+ colchoneta €
Total frame
+ pad cush. €

+

tejido A
A fabric

0335600--

1.135

3.720

tejido B
B fabric

0335600--

1.165

3.750

tejido C
C fabric

0335600--

1.355

3.940

tejido D
D fabric

0335600--

1.510

4.095

tejido cliente 137 cm.:
COM fabric 54":

033560099

1.135

3.720

Largo 615 cm.
Length 242"

club hamaca
hammock

pintura aluminio
aluminium painting

código
code

m³
m³

kg
kg

€

color pintura / tejido (solo vinytex slings)
painting colour / fabric (only slings vinytex)

03333--/--

0,06

10

560

funda impermeable
waterproof cover

033390025

255

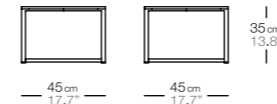

club mesa baja 45x45
side table

pintura aluminio
aluminium painting

sobre mesa
table top

código
code

m³
m³

kg
kg

€

color pintura
painting colour

compacto blanco
white compact

03703--50

0,15

7

505

color pintura
painting colour

aluminio pintado
painted aluminium

03703--/--

0,15

7

430

funda impermeable
waterproof cover

037092325

125

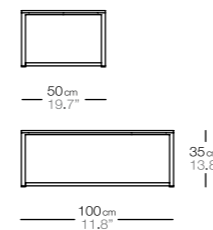

club mesa baja 100x50
side table

pintura aluminio (estruct.)
aluminium painting (frame)

pintura sobre aluminio
aluminium top painting

código
code

m³
m³

kg
kg

€

color pintura
painting colour

mismo color que estructura
same color as frame

03700--/--

0,23

5

575

funda impermeable
waterproof cover

037095925

170

Medidas: ancho x fondo x alto (cm.)

Programa de mesas de pie central fabricado con estructura de aluminio extruido y acabado con pintura poliéster.

Base fabricada en acero y tratamiento de cataforesis.

Incluye patas regulables en altura.

Sizes: width x depth x height (cm.)

Central leg table program made of extruded aluminium and final finish made with polyester powder coating.

Base made of steel with cataphoresis treatment.

Includes adjustable feet.

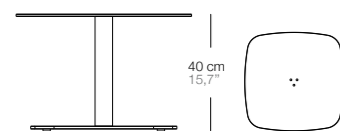

mesa sirkel 40
40 table

Ø60x40h.
Ø23,6"x15,7"h.

60x60x40h.
23,6"x23,6"x15,7"h.

| | código code | m ³ m ³ | kg kg | € | código code | m ³ m ³ | kg kg | € |
|---------------------------------------|----------------|----------------------------------|----------|-------|----------------|----------------------------------|----------|-------|
| compact blanco white compact | 2600605--50 | 0,18 | 20 | 800 | 2660605--50 | 0,18 | 21 | 800 |
| aluminio aluminum | 2600605--/-- | 0,18 | 21 | 800 | 2660605--/-- | 0,18 | 23 | 800 |
| dekton dekton | 2600605--/-- | 0,18 | 22 | 1.255 | 2660605--/-- | 0,18 | 24 | 1.220 |
| funda impermeable waterproof cover | 26006050925 | | | 125 | 26606050925 | | | 125 |

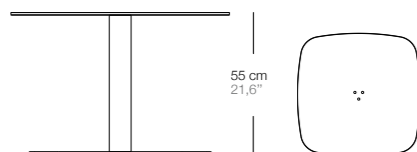

mesa sirkel 55
55 table

Ø60x55h.
Ø23,6"x21,6"h.

60x60x55h.
23,6"x23,6"x21,6"h.

Ø70x 55h.
Ø27,5"x21,6"h.

70x70x 55h.
27,5"x27,5"x21,6"h.

Ø75x 55h.
Ø29,5"x21,6"h.

| | código code | m ³ m ³ | kg kg | € | código code | m ³ m ³ | kg kg | € | código code | m ³ m ³ | kg kg | € | código code | m ³ m ³ | kg kg | € | código code | m ³ m ³ | kg kg | € |
|---------------------------------------|----------------|----------------------------------|----------|-------|----------------|----------------------------------|----------|-------|----------------|----------------------------------|----------|-------|----------------|----------------------------------|----------|-------|----------------|----------------------------------|----------|-------|
| compact blanco white compact | 2600606--50 | 0,35 | 21 | 845 | 2660606--50 | 0,35 | 22 | 845 | 2600706--50 | 0,35 | 22 | 965 | 2670706--50 | 0,35 | 24 | 965 | 2600756--/50 | 0,37 | 31 | 1.085 |
| aluminio aluminum | 2600606--/-- | 0,35 | 22 | 845 | 2660606--/-- | 0,35 | 24 | 845 | 2600706--/-- | 0,35 | 24 | 965 | 2670706--/-- | 0,35 | 26 | 965 | 2600756--/-- | 0,37 | 36 | 1.085 |
| dekton dekton | 2600606--/-- | 0,35 | 23 | 1.295 | 2660606--/-- | 0,35 | 24 | 1.255 | 2600706--/-- | 0,35 | 29 | 1.395 | 2670706--/-- | 0,35 | 32 | 1.330 | 2600756--/-- | 0,37 | 38 | 1.865 |
| funda impermeable waterproof cover | 26006060925 | | | 160 | 26606060925 | | | 160 | 26007060925 | | | 180 | 26707060925 | | | 180 | 26007560925 | | | 180 |

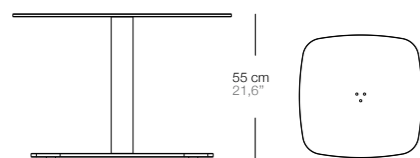

| mesa sirkel 55 55 table | | | | | 75x75x55h. 29,5"x29,5"x21,6"h. | | | | | Ø80x55h. Ø31,5"x21,6"h. | | | | | 80x80x55h. 31,5"x31,5"x21,6"h. | | | | | Ø90x55h. Ø35,4"x21,6"h. | | | | | 90x90x55h. 35,4"x35,4"x21,6"h. | | | | |
|---------------------------------------|----------------|----------------------------------|----------|-------|-----------------------------------|----------------|----------------------------------|----------|-------|----------------------------|----------------|----------------------------------|----------|-------|-----------------------------------|----------------|----------------------------------|----------|-------|----------------------------|----------------|----------------------------------|----------|-------|-----------------------------------|--|--|--|--|
| | código code | m ³ m ³ | kg kg | € | | código code | m ³ m ³ | kg kg | € | | código code | m ³ m ³ | kg kg | € | | código code | m ³ m ³ | kg kg | € | | código code | m ³ m ³ | kg kg | € | | | | | |
| compact blanco white compact | 2675756--50 | 0,37 | 33 | 1.085 | | 2660606--50 | 0,37 | 32 | 1.360 | | 2680806--50 | 0,37 | 34 | 1.360 | | 2600906--50 | 0,37 | 34 | 1.360 | | 2690906--50 | 0,37 | 36 | 1.360 | | | | | |
| aluminio aluminum | 2675756--/-- | 0,37 | 34 | 1.085 | | 2660606--/-- | 0,37 | 32 | 1.360 | | 2680806--/-- | 0,37 | 36 | 1.360 | | 2600906--/-- | 0,37 | 35 | 1.360 | | 2690906--/-- | 0,37 | 39 | 1.360 | | | | | |
| dekton dekton | 2675756--/-- | 0,37 | 42 | 1.645 | | 2660606--/-- | 0,37 | 33 | 1.940 | | 2680806--/-- | 0,37 | 45 | 1.695 | | 2600906--/-- | 0,37 | 36 | 2.055 | | 2690906--/-- | 0,37 | 50 | 1.805 | | | | | |
| funda impermeable waterproof cover | 26757560925 | | | 180 | | 26606060925 | | | 205 | | 2680800925 | | | 205 | | 26009060925 | | | 230 | | 26909060925 | | | 230 | | | | | |

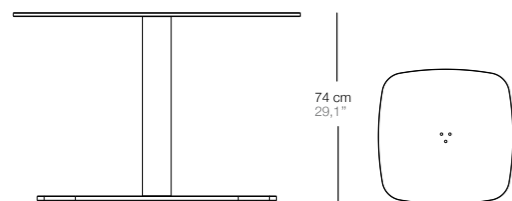

| mesa sirkel 74 74 table | | | | | Ø60x74h. Ø23,6"x29,1"h. | | | | | 60x60x74h. 23,6"x23,6"x29,1"h. | | | | | Ø70x74h. Ø27,5"x29,1"h. | | | | | 70x70x74h. 27,5"x27,5"x29,1"h. | | | | | Ø75x74h. Ø29,5"x29,1"h. | | | | | 75x75x74h. 29,5"x29,5"x29,1"h. | | | | |
|---------------------------------------|----------------|----------------------------------|----------|-------|----------------------------|----------------|----------------------------------|----------|-------|-----------------------------------|----------------|----------------------------------|----------|-------|----------------------------|----------------|----------------------------------|----------|-------|-----------------------------------|----------------|----------------------------------|----------|-------|-----------------------------|----------------|----------------------------------|----------|-------|-----------------------------------|--|--|--|--|
| | código code | m ³ m ³ | kg kg | € | | código code | m ³ m ³ | kg kg | € | | código code | m ³ m ³ | kg kg | € | | código code | m ³ m ³ | kg kg | € | | código code | m ³ m ³ | kg kg | € | | código code | m ³ m ³ | kg kg | € | | | | | |
| compact blanco white compact | 2600601--50 | 0,44 | 22 | 810 | | 2660601--50 | 0,44 | 23 | 810 | | 2600701--50 | 0,47 | 23 | 960 | | 2670701--50 | 0,47 | 25 | 960 | | 2600751--50 | 0,47 | 32 | 1.095 | | 2675751--50 | 0,47 | 34 | 1.095 | | | | | |
| aluminio aluminum | 2600601--/-- | 0,44 | 23 | 810 | | 2660601--/-- | 0,44 | 24 | 810 | | 2600701--/-- | 0,47 | 25 | 960 | | 2670701--/-- | 0,47 | 27 | 960 | | 2600751--/-- | 0,47 | 38 | 1.095 | | 2675751--/-- | 0,47 | 35 | 1.095 | | | | | |
| dekton dekton | 2600601--/-- | 0,44 | 24 | 1.280 | | 2660601--/-- | 0,44 | 25 | 1.240 | | 2600701--/-- | 0,47 | 30 | 1.380 | | 2670701--/-- | 0,47 | 33 | 1.310 | | 2600751--/-- | 0,47 | 40 | 1.860 | | 2675751--/-- | 0,47 | 44 | 1.640 | | | | | |
| funda impermeable waterproof cover | 26006010925 | | | 160 | | 26606010925 | | | 160 | | 26007010925 | | | 160 | | 26707010925 | | | 180 | | 26007510925 | | | 180 | | 26757510925 | | | 180 | | | | | |
| | | | | | Ø80x74h. Ø31,5"x29,1"h. | | | | | 80x80x74h. 31,5"x31,5"x29,1"h. | | | | | Ø90x74h. Ø35,4"x29,1"h. | | | | | 90x90x74h. 35,4"x35,4"x29,1"h. | | | | | Ø120x74h. Ø47,2"x29,1"h. | | | | | Ø140x74h. Ø55,1"x29,1"h. | | | | |
| | código code | m ³ m ³ | kg kg | € | | código code | m ³ m ³ | kg kg | € | | código code | m ³ m ³ | kg kg | € | | código code | m ³ m ³ | kg kg | € | | código code | m ³ m ³ | kg kg | € | | código code | m ³ m ³ | kg kg | € | | | | | |
| compact blanco white compact | 2600801--50 | 0,47 | 33 | 1.370 | | 2680801--50 | 0,47 | 35 | 1.370 | | 2600901--50 | 0,47 | 35 | 1.370 | | 2690901--50 | 0,47 | 38 | 1.370 | | 2601201--50 | 0,65 | 50 | 1.850 | | 2601401--50 | 0,65 | 75 | 1.860 | | | | | |
| aluminio aluminum | 2600801--/-- | 0,47 | 34 | 1.370 | | 2680801--/-- | 0,47 | 37 | 1.370 | | 2600901--/-- | 0,47 | 37 | 1.370 | | 2690901--/-- | 0,47 | 41 | 1.370 | | 2601201--/-- | 0,65 | 69 | 2.895 | | 2601401--/-- | 0,65 | 95 | 3.285 | | | | | |
| dekton dekton | 2600801--/-- | 0,47 | 35 | 1.935 | | 2680801--/-- | 0,47 | 46 | 1.690 | | 2600901--/-- | 0,47 | 37 | 2.050 | | 2690901--/-- | 0,47 | 51 | 1.800 | | 2601201--/-- | 0,65 | 69 | 2.895 | | 2601401--/-- | 0,65 | 95 | 3.285 | | | | | |
| funda impermeable waterproof cover | 26008010925 | | | 205 | | 26808010925 | | | 205 | | 26009010925 | | | 230 | | 26909010925 | | | 230 | | 26012010925 | | | 255 | | 26014010925 | | | 300 | | | | | |

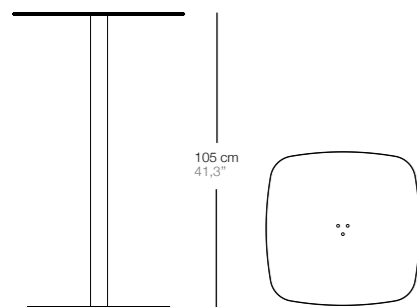
mesa sirkel 105
 105 table

Ø60x105h.
 Ø23,6"x41,3"h.

| | código code | m³ m ³ | kg kg | € |
|---------------------------------------|-----------------------|--|-----------------|----------|
| compact blanco white compact | 2600604--50 | 0,53 | 27 | 935 |
| aluminio aluminum | 2600604--/-- | 0,53 | 28 | 935 |
| dekton dektion | 2600604--/-- | 0,53 | 29 | 1.405 |
| funda impermeable waterproof cover | 26006040925 | | | 225 |

60x60x105h.
 23,6"x23,6"x41,3"h.

| | código code | m³ m ³ | kg kg | € |
|--|-----------------------|--|-----------------|----------|
| | 2660604--50 | 0,53 | 29 | 935 |
| | 2660604--/-- | 0,53 | 30 | 935 |
| | 2660604--/-- | 0,53 | 31 | 1.365 |
| | 26606040925 | | | 225 |

Ø70x105h.
 Ø27,5"x41,3"h.

| | código code | m³ m ³ | kg kg | € |
|--|-----------------------|--|-----------------|----------|
| | 2600704--50 | 0,60 | 29 | 1.145 |
| | 2600704--/-- | 0,60 | 31 | 1.145 |
| | 2600704--/-- | 0,60 | 36 | 1.505 |
| | 26007040925 | | | 225 |

70x70x105h.
 27,5"x27,5"x41,3"h.

| | código code | m³ m ³ | kg kg | € |
|--|-----------------------|--|-----------------|----------|
| | 2670704--50 | 0,60 | 31 | 1.145 |
| | 2670704--/-- | 0,60 | 33 | 1.145 |
| | 2670704--/-- | 0,60 | 39 | 1.435 |
| | 26707040925 | | | 225 |

Medidas: ancho x fondo x alto (cm.)

Programa de mesas de exterior/interior fabricado con estructura de aluminio extruido y acabado con pintura poliéster.
El sobre y las patas se sirven desmontadas.

Sizes: width x depth x height (cm.)

Outdoor/indoor table program made of extruded aluminium and final finish made with polyester powder coating.
Table tops and legs are delivered unassembled..

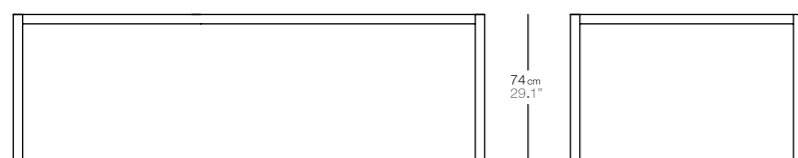
datos mesa 74
74 table

240x100
w.94.5" d.39.3" h29.1"

200x100
w.78.7" d.39.3" h29.1"

185x90
w.72,8" d.35.4" h29.1"

160x90
w.63" d.35.4" h29.1"

| | código code | m³ m ³ | kg kg | € | código code | m³ m ³ | kg kg | € | código code | m³ m ³ | kg kg | € | código code | m³ m ³ | kg kg | € |
|---|-----------------------|--|-----------------|----------|-----------------------|--|-----------------|----------|-----------------------|--|-----------------|----------|-----------------------|--|-----------------|----------|
| compact blanco white compact | D2401001--50 | 0,27 | 53 | 2.735 | D2001001--50 | 0,23 | 47 | 2.685 | D185901--50 | 0,20 | 42 | 2.585 | D160901--50 | 0,18 | 38 | 2.250 |
| compact otros colores compact other colors | D2401001--/-- | 0,27 | 53 | 2.875 | D2001001--/-- | 0,23 | 47 | 2.820 | D185901--/-- | 0,20 | 42 | 2.720 | D160901--/-- | 0,18 | 38 | 2.365 |
| madera iroko iroko wood | D2401001--70 | 0,27 | 45 | 3.680 | D2001001--70 | 0,23 | 41 | 3.465 | D185901--70 | 0,20 | 35 | 3.315 | D160901--70 | 0,18 | 33 | 3.140 |
| dekton dekton | D2401001--/-- | 0,27 | 76 | 2.900 | D2001001--/-- | 0,23 | 67 | 2.695 | D185901--/-- | 0,20 | 59 | 2.405 | D160901--/-- | 0,18 | 53 | 2.295 |
| funda impermeable waterproof cover | 054097325 | | | 390 | 054096025 | | | 330 | 054096625 | | | 310 | 054096125 | | | 275 |

datos mesa 74
74 table

140x90
w.55.1" d.35.4" h29.1"

140x140
w.55.1" d.55.1" h29.1"

90x90
w.35.4" d.35.4" h29.1"

| | código code | m³ m ³ | kg kg | € | código code | m³ m ³ | kg kg | € | código code | m³ m ³ | kg kg | € |
|---|-----------------------|--|-----------------|----------|-----------------------|--|-----------------|----------|-----------------------|--|-----------------|----------|
| compact blanco white compact | D140901--50 | 0,16 | 35 | 1.935 | D1401401--50 | 0,22 | 46 | 2.195 | D090901--50 | 0,12 | 27 | 1.640 |
| compact otros colores compact other colors | D140901--/-- | 0,16 | 35 | 2.035 | D1401401--/-- | 0,22 | 46 | 2.305 | D090901--/-- | 0,12 | 27 | 1.725 |
| madera iroko iroko wood | D140901--70 | 0,16 | 32 | 2.765 | D1401401--70 | 0,22 | 39 | 3.225 | D090901--70 | 0,12 | 25 | 1.965 |
| dekton dekton | D140901--/-- | 0,16 | 49 | 2.150 | D1401401--/-- | 0,22 | 64 | 2.625 | D090901--/-- | 0,12 | 38 | 1.750 |
| funda impermeable waterproof cover | 054096425 | | | 255 | 054096225 | | | 330 | 054096825 | | | 230 |

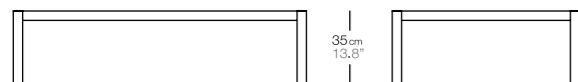
**dats mesa 35**
35 table**160x90**
w.63" d.35,4" h13,8"**140x90**
w.55.1" d.35,4" h13,8"**140x140**
w.55.1" d.55,1" h13,8"**90x90**
w.35.4" d.35,4" h13,8"

| | código code | m³ m ³ | kg kg | € | código code | m³ m ³ | kg kg | € | código code | m³ m ³ | kg kg | € | código code | m³ m ³ | kg kg | € |
|---|-----------------------|--|-----------------|----------|-----------------------|--|-----------------|----------|-----------------------|--|-----------------|----------|-----------------------|--|-----------------|----------|
| compact blanco white compact | D160903--50 | 0,16 | 34 | 2.175 | D140903--50 | 0,14 | 31 | 1.735 | D1401403--50 | 0,20 | 42 | 2.110 | D090903--50 | 0,1 | 23 | 1.560 |
| compact otros colores compact other colors | D160903--/-- | 0,16 | 34 | 2.285 | D140903--/-- | 0,14 | 31 | 1.825 | D1401403--/-- | 0,20 | 42 | 2.215 | D090903--/-- | 0,1 | 23 | 1.640 |
| madera iroko iroko wood | D160903--70 | 0,16 | 31 | 2.925 | D140903--70 | 0,14 | 29 | 2.550 | D1401403--70 | 0,20 | 35 | 2.790 | D090903--70 | 0,1 | 21 | 1.845 |
| dekton dekton | D160903--/-- | 0,16 | 49 | 2.175 | D140903--/-- | 0,14 | 45 | 1.975 | D1401403--/-- | 0,20 | 59 | 2.495 | D090903--/-- | 0,1 | 34 | 1.620 |
| funda impermeable waterproof cover | 056096125 | | | 275 | 056096425 | | | 255 | 056096225 | | | 330 | 056096825 | | | 230 |

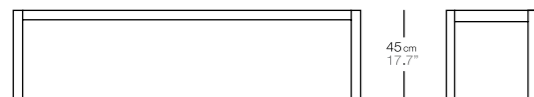
**dats banco 45**
45 bench**225x40**
w.88.6" d.15.7" h17.7"**200x40**
w.78,7" d.15.7" h17.7"**185x40**
w.72,8" d.15.7" h17.7"**145x40**
w.57" d.15.7" h17.7"

| | código code | m³ m ³ | kg kg | € | código code | m³ m ³ | kg kg | € | código code | m³ m ³ | kg kg | € | código code | m³ m ³ | kg kg | € |
|---|-----------------------|--|-----------------|----------|-----------------------|--|-----------------|----------|-----------------------|--|-----------------|----------|-----------------------|--|-----------------|----------|
| compact blanco white compact | D2254002--50 | 0,15 | 31 | 945 | D200402--50 | 0,13 | 28 | 1.705 | D185402--50 | 0,11 | 25 | 1.610 | D1454002--50 | 0,08 | 18 | 1.375 |
| compact otros colores compact other colors | D2254002--/-- | 0,15 | 31 | 995 | D200402--/-- | 0,13 | 28 | 1.790 | D185402--/-- | 0,11 | 25 | 1.690 | D1454002--/-- | 0,08 | 18 | 1.445 |
| dekton dekton | D2254002--/-- | 0,15 | 41 | 1.050 | D200402--/-- | 0,13 | 37 | 1.790 | D185402--/-- | 0,11 | 34 | 1.665 | D1454002--/-- | 0,08 | 25 | 1.550 |
| funda impermeable waterproof cover | 051299025 | | | 250 | 051298825 | | | 225 | 051296025 | | | 225 | 051296425 | | | 210 |

Cojín decoración



cojín decoración (4 esquinas)
decorative cushion (4 corners)

40x40
15,7"x15,7"

45x45
17,7"x17,7"

60x30
23,6"x11,8"

60x60
23,6"x23,6"

| | código <i>code</i> | € | código <i>code</i> | € | código <i>code</i> | € | código <i>code</i> | € |
|--|--------------------------------------|----------|--------------------------------------|----------|--------------------------------------|----------|--------------------------------------|----------|
| tejido A <i>A fabric</i> | 0184400-- | 80 | 0184500-- | 85 | 0183400-- | 85 | 0188400-- | 130 |
| tejido B <i>B fabric</i> | 0184400-- | 85 | 0184500-- | 90 | 0183400-- | 90 | 0188400-- | 135 |
| tejido C <i>C fabric</i> | 0184400-- | 90 | 0184500-- | 105 | 0183400-- | 95 | 0188400-- | 155 |
| tejido D <i>D fabric</i> | 0184400-- | 100 | 0184500-- | 115 | 0183400-- | 105 | 0188400-- | 180 |
| tejido cliente 137 cm.: <i>COM fabric 54"</i> | 018440099 | 80 | 018450099 | 85 | 018340099 | 85 | 018840099 | 130 |
| | Largo 55 cm. <i>Length 21,65"</i> | | Largo 65 cm. <i>Length 25,59"</i> | | Largo 65 cm. <i>Length 25,59"</i> | | Largo 75 cm. <i>Length 29,53"</i> | |



cojín decoración (platabanda)
decorative cushion (border edge)

40x40
15,7"x15,7"

60x30
23,6"x11,8"

60x60
23,6"x23,6"

| | código <i>code</i> | € | código <i>code</i> | € | código <i>code</i> | € |
|--|--------------------------------------|----------|--------------------------------------|----------|--------------------------------------|----------|
| tejido A <i>A fabric</i> | 0284400-- | 115 | 0283400-- | 130 | 0288400-- | 155 |
| tejido B <i>B fabric</i> | 0284400-- | 120 | 0283400-- | 135 | 0288400-- | 160 |
| tejido C <i>C fabric</i> | 0284400-- | 140 | 0283400-- | 155 | 0288400-- | 190 |
| tejido D <i>D fabric</i> | 0284400-- | 160 | 0283400-- | 180 | 0288400-- | 215 |
| tejido cliente 137 cm.: <i>COM fabric 54"</i> | 028440099 | 115 | 028340099 | 130 | 028840099 | 155 |
| | Largo 55 cm. <i>Length 21,65"</i> | | Largo 65 cm. <i>Length 25,59"</i> | | Largo 75 cm. <i>Length 29,53"</i> | |



tejido m.l. fabric l.m.

Tejido acrílico: 100% acrílico teñido en masa, resistente a los rayos UVA (clasif. 7/8), tratamiento antimanchas y repelente al agua. Lavabale a 30° C. Secado al aire libre.

Tejido vinytex: tejido sintético recubierto de poliéster. Resistente a los rayos UVA (clasif. 7/8).

Acrylic fabric: 100% solution dyed acrylic, UV resistance (class. 7/8) with stain and water repellent finish. Washable at 30°C. Open air drying.

Vinytex fabric: synthetic fabric made of plastic coated polyester. UV resistance (class. 7/8).

| tejidos acrílico (almohadones) <i>acrylic fabrics (cushions)</i> | código <i>code</i> | ancho cm / " <i>width cm / "</i> | tejido <i>fabric.</i> | € |
|--|-----------------------|-------------------------------------|--------------------------|-----|
| Acrílico pan white, ml. <i>pan white acrylic, ml.</i> | 511005847 | 160 | B | 60 |
| Acrílico wabi ecru, ml. <i>wabi ecru acrylic, ml.</i> | 5110058103 | 160 | C | 85 |
| Acrílico pan bone, ml. <i>pan bone acrylic, ml.</i> | 511005848 | 140 | B | 60 |
| Acrílico heather chalk ml. <i>heather chalk acrylic, ml.</i> | 511005887 | 140 | B | 60 |
| Acrílico sack sand , ml. <i>sack sand acrylic, ml.</i> | 511005883 | 140 | D | 130 |
| Acrílico bon chalk linen ml. <i>can yeallow sun acrylic, ml.</i> | 511005895 | 140 | C | 85 |
| Acrílico wabi beige, ml. <i>wabi beige acrylic, ml.</i> | 5110058104 | 160 | C | 85 |
| Acrílico grey pearl, ml. <i>grey pearl acrylic, ml.</i> | 511005832 | 160 | B | 60 |
| Acrílico Toast, ml. <i>toast acrylic, ml.</i> | 511005831 | 137 | B | 60 |
| Acrílico wabi basalto, ml. <i>wabi basalto acrylic, ml.</i> | 5110058100 | 160 | C | 85 |
| Acrílico Beige carbón, ml. <i>beige carbon acrylic, ml.</i> | 511005842 | 140 | B | 60 |
| Acrílico Sack carbón, ml. <i>sack carbon acrylic, ml.</i> | 511005889 | 140 | D | 130 |
| Acrílico marconi antracita, ml. <i>marconi antracita acrylic, ml.</i> | 511005874 | 140 | B | 85 |
| Acrílico can bali blue, ml. <i>can bali blue acrylic, ml.</i> | 511005893 | 140 | C | 85 |
| Acrílico Azul gris/blue grey, ml. <i>blue grey acrylic, ml.</i> | 511005843 | 140 | B | 60 |
| Acrílico marconi light blue, ml. <i>marconi light blue acrylic, ml.</i> | 511005875 | 140 | B | 85 |
| Acrílico Sack cloudy blue, ml. <i>sack cloudy blue acrylic, ml.</i> | 511005806 | 140 | D | 130 |
| Acrílico terra navy blue, ml. <i>terra navy blue acrylic, ml.</i> | 511005894 | 175 | C | 120 |
| Acrílico marconi marine blue, ml. <i>marconi marine blue acrylic, ml.</i> | 511005871 | 140 | B | 85 |
| Acrílico can valley green, ml. <i>can valley green acrylic, ml.</i> | 511005892 | 140 | C | 85 |
| Acrílico sack olive green, ml. <i>sack olive green acrylic, ml.</i> | 511005846 | 140 | D | 130 |
| Acrílico marconi green, ml. <i>marconi green acrylic, ml.</i> | 511005872 | 140 | B | 85 |
| Acrílico can yellow sun, ml. <i>can yeallow sun acrylic, ml.</i> | 511005890 | 140 | C | 85 |
| Acrílico sol mustard, ml. <i>sol mustard acrylic, ml.</i> | 511005891 | 140 | A | 50 |
| Acrílico pan tangerine, ml. <i>pan tangemine acrylic, ml.</i> | 5110058101 | 160 | B | 60 |
| Acrílico Blush peach, ml. <i>blush peach acrylic, ml.</i> | 511005853 | 137 | B | 60 |
| Acrílico peach flamingo, ml. <i>peach flamingo acrylic, ml.</i> | 511005885 | 140 | B | 60 |
| Acrílico marconi indian red <i>marconi indian red acrylic, ml.</i> | 511005873 | 140 | B | 85 |

| tejidos vinytex (almohadones) <i>vinytex fabrics (cushions)</i> | código <i>code</i> | ancho cm / " <i>width cm / "</i> | tejido <i>fabric</i> | € |
|--|-----------------------|-------------------------------------|-------------------------|-----|
| vinytex tabaco, ml <i>tobacco vinytex, ml</i> | 511105805 | 145 / 57 | B | 55 |
| vinytex blanco perla, ml <i>white pearl vinytex, ml</i> | 511105808 | 145 / 57 | B | 55 |
| vinytex stone beige, ml. <i>stone beige vinytex, ml</i> | 511105861 | 180 / 70 | D | 140 |
| vinytex grafito beige, ml. <i>grafito beige vinytex, ml</i> | 511105852 | 180 / 70 | D | 140 |
| vinytex eden tobacco, ml <i>eden tobacco vinytex, ml</i> | 511105863 | 180 / 70 | D | 140 |
| vinytex eden black, ml <i>eden black vinytex, ml</i> | 511105877 | 180 / 70 | D | 140 |

colores (pinturas y tejidos) colors (paintings and fabrics)

Tejido vinytex: tejido sintético recubierto de poliéster. Resistente a los rayos UVA (clasif. 7/8).

Vinytex fabric: synthetic fabric made of plastic coated polyester. UV resistance (class. 7/8).

| tejidos vinytex (slings) vinytex fabrics (slings) | código code |
|--|----------------|
| basque green | 21 C |
| black | 22 A |
| antracita | 03 A |
| white | 01 A |
| brown | 07 C |
| grey beige | 20 C |

| tejidos vinytex (almohadones) vinytex fabrics (cushions) | código code |
|---|----------------|
| tobacco | 05 B |
| white pearl | 08 B |
| stone beige | 61 D |
| grafito beige | 52 D |
| eden tobacco | 63 D |
| eden black | 77 D |

Todos nuestros productos pueden ser acabados en los siguientes colores de pintura en polvo poliéster.

All our products can be finished in the following polyester powder coating colors.

| pintura painting | código code |
|---------------------|----------------|
| white text | 10 |
| ivory text | 11 |
| brown cobre | 26 |
| grafito | 34 |
| antracita | 23 |
| beige grey | 39 |
| stone | 29 |
| maroon oxide | 16 |
| cement green | 12 |
| olive green | 15 |
| grey blue | 24 |
| steel blue | 49 |
| olive brown | 56 |
| coral red | 55 |
| mint turquoise | 52 |

Tejido acrílico: 100% acrílico teñido en masa, resistente a los rayos UVA (clasif. 7/8), tratamiento antimanchas y repelente al agua. Lavable a 30° C. Secado al aire libre.

Acrylic fabric: 100% solution dyed acrylic, UV resistance (class. 7/8) with stain and water repellent finish. Washable at 30°C. Open air drying.

| tejidos acrílico (almohadones) acrylic fabrics (cushions) | código code |
|--|----------------|
| pan white | 47 B |
| wabi ecru | 103 C |
| pan bone | 48 B |
| heather chalk | 87 C |
| sack sand | 83 D |
| bon chalk linen | 95 C |
| wabi beige | 104 C |
| grey pearl | 32 B |
| toast | 31 B |
| wabi basalto | 100 C |
| beige carbón | 42 B |
| sack carbón | 89 D |
| marconi antracita | 74 B |
| can bali blue | 93 C |
| blue grey | 43 B |
| marconi light blue | 75 B |
| sack cloudy blue | 06D |
| terry navy blue | 94 C |
| marconi marine blue | 71 B |
| can valley green | 92 C |
| sack olive green | 46 D |
| marconi green | 72 B |
| can yellow sun | 90 C |
| sol mustard | 91 A |
| pan tangerine | 101 B |
| blush peach | 53 B |
| peach flamingo | 85 B |
| marconi indian red | 73 B |

sobres mesa table tops

| compact compact | código code | aluminio aluminium | código code | dekton dekton | código code |
|------------------------|----------------|-----------------------|----------------|------------------------|----------------|
| blanco white | 50 | white text | 10 | danae danae | 78 |
| antracita antracita | 51 | ivory text | 11 | keranium keranium | 82 |
| marrón brown | 54 | brown cobre | 26 | domoos domoos | 04 |
| | | grafito | 34 | marina marina | 106 |
| | | antracita | 23 | argentium argentium | 105 |
| | | beige grey | 39 | sirocco sirocco | 107 |
| | | stone | 29 | | |
| | | maroon oxide | 16 | | |
| | | cement green | 12 | | |
| | | olive green | 15 | | |
| | | greu blue | 24 | | |
| | | steel blue | 49 | | |
| | | olive brown | 56 | | |
| | | coral red | 55 | | |
| | | mint turquoise | 52 | | |

mantenimiento productos maintenance products



limpiador vinytex, textile 0,5 l.
Vinytex, textile cleaner 0,5 l.

| código code | € |
|----------------|----|
| 1053430555 | 60 |



limpiador y pulidor acero inoxidable 0,5 l.
stainless steel cleaner & polisher 0,5 l

| | |
|------------|----|
| 1053079209 | 60 |
|------------|----|

condiciones generales de venta 2023

precios / producto

- Los precios de esta tarifa son precios de venta al público recomendados.
- Salvo aumento en los costos de fabricación, oscilaciones considerables en el tipo de cambio de las divisas que nos obliguen a modificar los precios actuales, esta tarifa tendrá validez hasta el 31 de diciembre de 2023. Cualquier cambio de precios será notificado a la recepción del pedido.
- Bivaq (la Compañía), se reserva el derecho de anular o modificar cualquier producto, material, color u otros elementos de sus colecciones sin previo aviso.
- La Compañía declina toda responsabilidad si por el uso indebido de sus productos se produjera cualquier accidente.

pedidos

- Todos los pedidos deberán cursarse por escrito, considerándose en firme, y entendiéndose, por ello, que se aceptan todas nuestras condiciones generales de venta.
- No se aceptará ninguna variación o anulación de un pedido que no haya sido comunicado por escrito antes de los 8 días siguientes a la fecha del mismo. Todos los gastos que se generen por haber salido la mercancía del almacén irán a cargo del cliente.
- En caso de solicitar únicamente los rellenos de los almohadones o en caso de solicitar las fundas, se aplicará una reducción del 30% sobre el precio del almohadón indicado en esta tarifa.
- En caso de pedido con referencias no-estándares se deberá abonar por adelantado el 100% del valor facturado. El producto se empezará a fabricar a la recepción del pago.

reclamaciones

- El cliente deberá revisar siempre la mercancía haciendo constar en el albarán de entrega, la fecha de recepción, persona que lo recibe y el sello de la empresa, así como las anomalías detectadas en el material.
- Daños VISIBLES: Cualquier reclamación, si existen daños visibles a la entrega de la mercancía, se debe de indicar con carácter obligatorio en el albarán de entrega del transportista firmado por el destinatario y con las anotaciones de la incidencia, y éste dispondrá de un plazo máximo de 24 horas para reclamar por escrito/e-mail los daños concretos.
- Daños NO VISIBLES: Si existen daños no visibles a la entrega de la mercancía, estos se deberán de notificar por escrito/email a Bivaq en el plazo máximo indicado a continuación y teniendo como referencia la fecha y hora de la recepción de la mercancía:

- Terrestre o marítimo Nacional: 24 horas
- Terrestre Internacional: 7 días

- Cualquier reclamación efectuada fuera del plazo arriba indicado queda automáticamente sin efecto alguno.
- La utilización por parte del cliente (a la recepción de la mercancía del sello "salvo examen" no exime de responsabilidad a éste para notificar en tiempo y forma la reclamación correspondiente.
- La reclamación ha de ser cursada por e-mail info@bivaq.com, haciendo constar número de la expedición, no y fecha del albarán, fecha de recepción de la mercancía, problema y número de piezas a las que afecta.
- En el caso de realizarse una devolución, únicamente se aceptarán después de haberla autorizado por escrito nuestro representante o departamento comercial.
- Todas las devoluciones deberán realizarse en su embalaje original y a portes pagados.
- Si la Compañía, después de recibir la mercancía, confirma que es defectuosa, se reserva el derecho a decidir entre reemplazar los productos libres de gastos o abonar el precio completo de la compra. En este último caso, los importes correspondientes serán descontados de posteriores facturas.

portes / forma de pago

- Primer pedido: se establece un pedido mínimo de 900 € (IVA no incluido) que se pagará por transferencia bancaria. Los gastos ocasionados por este sistema de cobro irán a cargo del cliente. Portes pagados para envíos a Península. España: Portes pagados para pedidos superiores a 1.500€ (IVA no incl.). Los pedidos inferiores a ese importe se aplicará un cargo en concepto de transporte de 125€. Para los envíos a las Islas Canarias, Baleares, Ceuta y Melilla, los precios se entenderán mercancía puesta en Barcelona. Si desea el envío hasta destino a portes pagados, el importe de la factura se incrementará en un 12% para las Islas Canarias, Ceuta y Melilla y un 5% para las Islas Baleares.
- Los precios señalados en estas tarifas son para mercancía en destino (almacén cliente) a portes pagados, excepto: **Países A:** Francia, Benelux, Italia. El importe mínimo neto del pedido para no facturar gastos de transporte es 3.000€. Los pedidos inferiores a ese importe se aplicará un cargo en concepto de transporte de 150€. **Países B:** Suiza, Alemania, Austria, UK. El importe mínimo neto del pedido para no facturar gastos de transporte es 3.500 €. Los pedidos inferiores a ese importe se aplicará un cargo en concepto de transporte de 200€. **Países C:** En el resto de Europa el importe mínimo del pedido para no facturar gastos de transporte es 4.000 €. Los pedidos inferiores a ese importe se aplicará un cargo en concepto de transporte de 300€. **Resto países:** En el resto del mundo las condiciones son Ex Works fábrica.

garantía

- Para uso doméstico, los productos Bivaq, excepto almohadones, fundas y tejidos, están garantizados por un período de cinco años, bajo condiciones normales de uso y mantenimiento, contra cualquier defecto de fabricación que afecte la funcionalidad de los mismos. Esta garantía no se aplicará a defectos o imperfecciones resultantes del paso normal del tiempo. Circunstancias no cubiertas por esta garantía incluyen leves cambios de color, cambios de textura de la madera pequeñas rayadas o manchas en la pintura debidas al uso normal del mobiliario... En caso de utilizar un sistema de limpieza no recomendado por Bivaq, el producto no quedará cubierto por la garantía.
- Para uso no doméstico, hoteles, catering, colectividades..., los productos de Bivaq, excepto almohadones, fundas y tejidos están garantizados por un periodo de dos años contra cualquier defecto de fabricación que pueda afectar su uso normal. Esto es aplicable en condiciones normales de uso y mantenimiento. Esta garantía se ofrece en las mismas condiciones anteriormente mencionadas.

jurisdicción / reserva de dominio

- Por la suscripción de los pedidos que se originen, el comprador se somete expresamente a la Jurisdicción de los Juzgados y Tribunales de Barcelona, con renuncia a su propio fuero, de ser distinto.
- La Compañía se reserva el dominio de la mercancía hasta realizado el pago, quedando en poder del cliente, en calidad de depósito. Bivaq o sus representantes, podrán retirar la mercancía en caso de impago.

bivaq

Av. J.V.Foix 72-74
08034 Barcelona (Spain)
(+34) 93 205 75 95
info@bivaq.com
bivaq.com

Advertencia: todos los diseños que contiene éste catálogo están protegidos desde la fecha de su creación por las leyes y convenios internacionales sobre copyright. © 2023

Notice: all designs concerning the products inside this catalogue are protected from the date of creation of such designs under international copyright laws and conventions. © 2023